



Systems Reference Library

IBM 2821 Control Unit Component Description

This reference publication presents a description of input/output operations controlled through the IBM 2821 Control Unit. The IBM 2540 Card Read-Punch and the IBM 1403 and 1404 Printers controlled by the IBM 2821 Control Unit are briefly described. Commands, status, and sense information pertaining to the attached input/output units is presented. Programming timing considerations for control unit, card reader, card punch, and printers are also presented.

For further information about the attached input/output units, refer to IBM 2540 Card Read-Punch, Form A21-9033, IBM 1403 Printer, Form A24-3073, and IBM 1404 Printer, Form A24-1446. For further information about input/output and channel operations, refer to IBM System/360 Principles of Operation, Form A22-6821. Other related literature is listed in IBM System/360 Bibliography, Form A22-6822.



Eighth Edition, November 1969

This is a reprint of A24-3312-6 incorporating changes released in the following Technical Newsletter.

Form Number

N24-0428

Date

April 14, 1969

Significant changes or additions to the specifications contained in this publication are continually being made. When using this publication in connection with the operation of IBM equipment, check the latest SRL Newsletter for revisions, or contact the local IBM Branch Office.

Copies of this and other IBM publications can be obtained through IBM Branch Offices. This manual has been prepared by the IBM Systems Development Division, Product Publications, Dept. 171, P.O. Box 6, Endicott, New York 13760. Address comments regarding this publication to the above address.

CONTENTS

IBM 2821 CONTROL UNIT	5	Special Features	28
Channels	6	Programming Timing Considerations	29
Units Controlled	7	IBM 2540 Use Meter	30
Data Movement	8		
Concurrent Operation	8	PRINTERS	31
Attachment Method	8	Printing Principles	34
2821 Switches	8	Operation Commands	35
Data Codes	9	Status Byte	36
Buffering	9	Sense Byte	36
System Reset	9	Possible Combinations of Status Bits	
Malfunction Reset (Selective Reset)	10	in a Status Byte (for 1403 and 1404)	37
Interface Disconnect	11	Possible Combinations of Sense Bits	
Preferred Addresses	11	in a Sense Byte	41
Special Features Controlled	11	Diagnostic Commands for the 1403 Controls	42
Customer Engineering Control Panel	11	Use Meter	42
		Printer Keys and Indicators	42
IBM 2540 CARD READ-PUNCH	12	Special Features	44
IBM 2540 Reader – Method of Operation	12	Programming Timing Considerations	
IBM 2540 Punch – Method of Operation	13	(for Printers without the Universal	
Termination Operations	14	Character Set Feature)	58
Operation Commands	14	IBM 1404 Printer	59
Data Codes	20		
Status Byte	21	TWO-CHANNEL-SWITCH SPECIAL FEATURE	65
Sense Byte	22	Program Control of Switching	66
Status Byte Bit Combinations	23	Operations with the Two-Channel Switch	68
Possible Combinations of Sense Bits			
in a Sense Byte	26	INDEX	71
Diagnostic Commands			
for the 2540 Controls	26		
Keys, Switches, and Indicators	27		

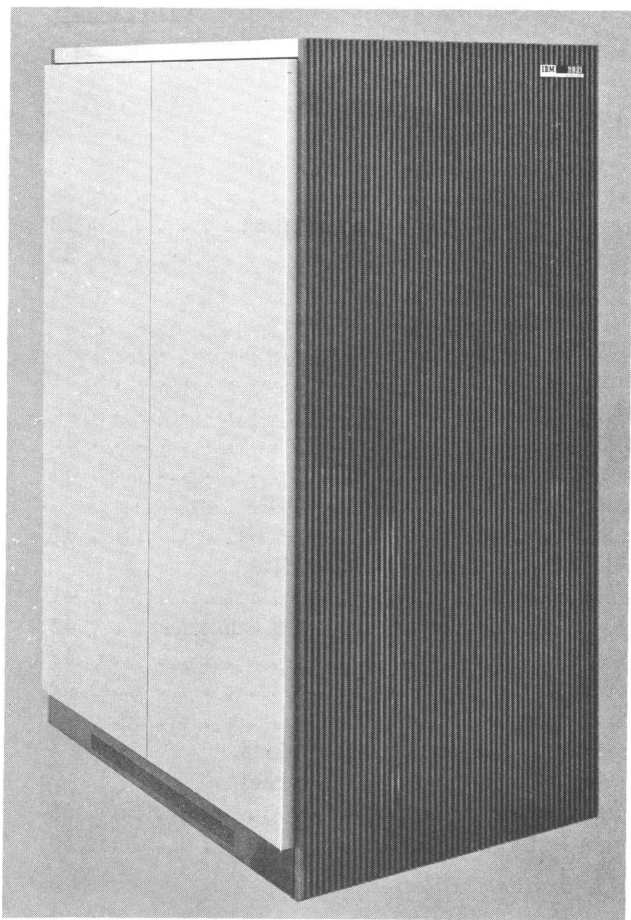

Figure 1. IBM 2821 Control Unit

This publication describes the IBM 2821 Control Unit, which provides controlling circuitry for the IBM 2540 Card Read-Punch, and the IBM 1403 and 1404 Printers that can be used as input or output devices with various models of the IBM System/360. Control information and data transferred between the processing unit and 2821-controlled input/output (I/O) devices pass through the IBM 2821 Control Unit.

The movement of data between input/output devices and the processing unit of a data processing system is shown in Figure 2. The flow of job data and control information between the processing unit in System/360 and an input or output device is shown in Figure 3. The input/output devices are attached directly to control units. (Note that the control units for some I/O devices are contained in the I/O devices themselves. This is not the case, however, for I/O devices attached to the 2821.) The control units are attached to the channel through a standard I/O interface. This interface is a group of connecting lines that carries data and control information between the control units and the channel.

The 2821 contains areas of storage (buffers) that permit high-speed transfer of information between the processing unit and the input/output devices. This arrangement permits maximum use of the processing-unit in arithmetic and logic operations because the processing unit is not restricted to the slower-speed operation of input/output devices. For example, in a card-read operation the information from the card is loaded into a buffer in the IBM 2821 Control Unit. This loading proceeds at card-reader speed. When the processing unit is ready to accept the data, it is transferred from the buffer to the processing unit at a rate that does not depend upon reading time in the card reader.

While the next card is being read, the processing unit can proceed with other operations; the processing unit is not restricted to card-reading speed during

this input operation. When the processing unit is again ready for card data, that data can be transferred from the buffer to the processing unit.

Consider what generally occurs during an input/output operation. Arithmetic- and logic-decision operations are performed while the processing unit is in the problem state. For an input/output operation to be started, the processing unit must be placed in the supervisor state. The transition from problem state to supervisor state (to initiate an I/O operation) is normally effected when a Supervisor Call instruction is encountered in the program.

The input/output operation is a part of the overall job performed by the system. A way must be provided to return to the right place in the program to resume operations in the problem state as soon as the functions performed in the supervisor state are completed. Therefore, when the system state is changed from problem to supervisor, the place in the program that is to be used, after the operation performed in the supervisor state has been completed, must be known. This information is contained in the appropriate Program Status Word (PSW). When the Supervisor Call instruction is executed, the PSW relating to the problem state just interrupted is stored. At this time, a new PSW is used that contains information related to the operation to be performed in the supervisor state. After supervisor-state operations are completed, the PSW that was used in the supervisor state is stored for possible subsequent use. Conditions returned-to after the supervisor-state operations have been completed are indicated by the next PSW used. For instance, the next PSW used indicates the location in main storage of the next instruction to be performed.

As soon as the transition to the supervisor state is effected, the supervisor program takes over control of the system. The program routines of the supervisor program are provided by IBM (though they

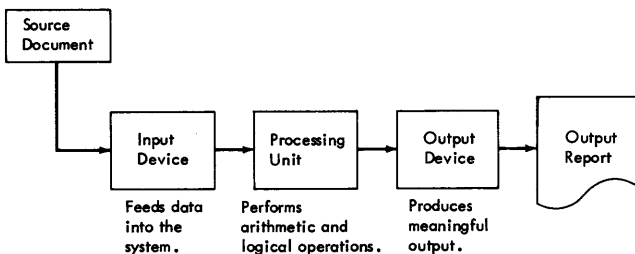

Figure 2. Basic Data Processing System

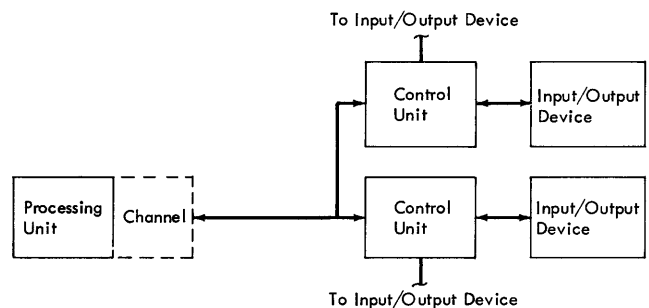

Figure 3. Input/Output Data Flow

may be written by the user). Specifications such as device-designation (related to the input/output operation to be performed) are written by the user and entered into the system as part of the user's original source program. These specifications are entered into the supervisor program during generation of the object program that controls the system during job runs.

The supervisor program contains a Start I/O instruction. This instruction indicates the channel, and the input or output device on that channel, that is to be used. Assume that the channel and device are free to perform the operation specified. At this time, a Channel Address Word (CAW) is referenced from main storage. The particular CAW is determined by the supervisor program. The CAW contains the main-storage address of the first Channel Command Word (CCW) to be used in the operation. The CCW specifies:

1. The operation to be executed by the input/output device.
2. The area of main storage (if any) to be used in the operation.
3. The amount of data (number of bytes), if any, to be transferred in the operation.

Assume that the operation requested is transferring the information read from one card into main storage, and that this information is already in the internal storage area (read buffer) of the 2821. The information was read into that buffer during a previous card-read cycle in the card reader. A CCW directs that the data be transferred from the control-unit buffer to the processing unit.

As soon as the information in the buffer of the control unit is sent to the processing unit, a card-read cycle takes place in the card reader to refill the control-unit buffer with new information (if a read and feed command was given). Because the card reader is busy during the card-read cycle, no other operations with the card reader are permitted. However, the processing unit is free to carry out other operations while the card-read operation is taking place.

Termination of the input/output operation with the channel is signaled by channel-end, which indicates that the channel is free to transfer information between other attached devices and the processing unit. (Note, however, that a channel may service more than one device at a time.) Device-end signals that the device is no longer busy with an operation. In the case of the card reader in this example, device-end occurs after the mechanical portion of the card-read cycle is completed. Also, at the end of the operation,

a Channel Status Word (CSW) is stored in main storage to indicate the status of the input/output device. For instance, an error may have occurred in the reader during the operation. This fact is reflected in the CSW.

In summary, to initialize an input/output (I/O) operation requires execution of a Start I/O instruction. During processing of the Start I/O, the first CCW, whose location is specified in the CAW, is accessed. The I/O unit is selected and directed to perform the operation specified in the CCW. The channel then takes over and controls the input/output operation as defined by the CCW. The CCW contains the necessary information for completing the operation. After the operation is completed, the input/output device initiates an input/output interruption to signal the processing unit. The processing unit, in accepting the interruption, stores a Channel Status Word (CSW) into a fixed storage location. This CSW contains the status for the input/output operation that caused the interruption. The CSW is available in its fixed storage location until another CSW is stored later for another I/O operation. Data or command chaining, or unusual conditions detected at the I/O unit or in the channel, can cause the operation to proceed in various ways. For specific details concerning System/360 I/O programming considerations, refer to IBM System/360 Principles of Operation, Form A22-6821.

CHANNELS

A channel is a device used to complete control of I/O units attached to the processing unit. It controls the transmission of data between the processing unit and the I/O units and from there to main storage.

The IBM System/360 has two types of channels: the multiplexer channel and the selector channel. (Note that the types and number of channels depend upon the System/360 model used.) Both perform the same type of function, the control of attached input/output devices, but each employs a different method to accomplish this. The high speed of the processing unit and the relatively slow speed of many I/O devices makes it desirable to have a channel that can operate several I/O devices at one time. The multiplexer channel was designed for this purpose. By having many subchannels (each capable of sustaining a single I/O operation), the multiplexer channel can read or write from several low-speed I/O devices at one time (in overlap fashion). As each I/O device requests to send or receive data, the multiplexer channel selects the correct subchannel for the requesting input/output device and sends or receives data to or from that device, under control of the subchannel.

Processing-unit circuitry, depending upon the System/360 Model, may be shared by both the processing unit and the multiplexer channel. If the circuitry is shared, whenever the multiplexer channel is operating the processing-unit program in progress is stopped. The correct subchannel address is then developed from the device address, the subchannel data is loaded into the processing-unit circuitry, and the input/output operation is performed. After the portion of the input/output operation that requires use of the processing unit circuitry is completed, the updated subchannel data is stored, and the processing-unit circuitry is reloaded from the stored processing-unit information. The next processing-unit program step can then take place.

A selector channel allows simultaneous processing-unit and channel operations with high-speed input/output devices. When the selector channel is ready either to store or fetch data from main storage, it stops the processing unit (or multiplexer channel operations) while it takes a storage cycle. This operation is called a selector-share cycle. This operation is automatic in that, at its completion, control is returned to the operation that was in progress.

Initial selection of the I/O device and CCW chain-cause the first or next CCW to be fetched from storage by microprogramming (method may differ according to central processing unit model, but the result is compatible throughout System/360) and stored in the selector-channel circuitry. Because the selector channel has its own registers, processing-unit registers are not stored or restored in a selector channel data cycle as would be the case in a multiplexer channel microprogram operation.

Selector channels have only one subchannel, which means they can operate only in burst mode (no data interleaving) with one I/O device at any one time. This is why the IBM System/360 is designed to use up to six selector channels and only one multiplexer channel. Note that the number of channels used depends upon the specific System/360 model and the particular configuration of that model used.

UNITS CONTROLLED

Several models of the 2821 are available. These models provide System/360 I/O interface adaptation, control circuitry, and record buffering for the:

- IBM 2540 Card Read-Punch,
- IBM 1403 Printer, Model, 2, 3, 7, or N1,
- IBM 1404 Printer, Model 2.

The IBM 2540 Card Read-Punch reads at a maximum rate of 1000 cards per minute and punches at a maximum rate of 300 cards per minute.

The printers that can be used with the IBM 2821 have the following characteristics:

	<u>Print Position</u>	<u>Maximum Print Speed* in Lines per Minute</u>
IBM 1403 Model 2	132	600
IBM 1403 Model 3	132	1100
IBM 1403 Model N1	132	1100
IBM 1403 Model 7	120	600
IBM 1404 Model 2	132	600

*Without the Universal Character Set feature installed.

The 1404 can also print on card documents at a maximum rate of 800 cards per minute in a two-up manner (two cards, side by side). IBM 1404 printers can be attached to a 2821 on System/360 Models 30, 40, and 50 only. The basic configurations of the IBM 2821 models and the units controlled are:

- Model 1 controls and buffers one 2540 and one 1403 printer.
- Model 2 controls and buffers one 1403 printer.
- Model 3 controls and buffers two 1403 printers.
- Model 4 controls and buffers a 2540 and a 1404, Model 2 printer.
- Model 5 controls and buffers a 2540 and two 1403 printers.

Attachment of any 1403 printer to the IBM 2821 Control Unit Models 1, 2, 3, or 5 requires that the appropriate prerequisite be on the 2821. A third printer can be attached to the IBM 2821 Control Unit Model 3 or 5 only. For this attachment, a third printer control is required on the 2821. Also, an 1100 LPM Adapter is required on any 2821 connection to which an IBM 1403 Printer Model 3 or N1 is to be attached. Refer to your IBM Sales Representative for information on ordering specific configurations.

Placement of I/O units on a channel determines priority of device operation. Printers attached to a 2821 can be considered a subgroup within a channel priority scheme. When simultaneous requests for I/O service occur, the requesting unit of highest priority obtains channel service before any other units of lower priority. Within a subgroup of 1403 printers attached to a 2821, one of these printers has the highest priority in relation to the one or two other 1403 printers attached to the same 2821. Therefore, when ordering a 2821 and attached printers, the desired channel priority of the printers must be specified. For example, suppose that an IBM 2821 Control Unit Model 5 and three attached printers are ordered. Assume that the printers are

a 1403 Model 2, a 1403 Model 7, and a 1403 Model 3, and the desired priority of printer service is:

First Priority	1403-3
Second Priority	1403-2
Third Priority	1403-7

Then ordering should reflect the priority as follows:

First Priority	Printer Control Number 1	1403-3
Second Priority	Printer Control Number 2	1403-2
Third Priority	Printer Control Number 3	1403-7

(Note that the attached 2540 reader and punch normally take priority over any attached printers.)

Once priority sequence has been established, any special features must be indicated for the appropriate printer. If, for example, the 1403 Model 3 in the preceding example is to have the Selective Tape Listing feature, then that feature must be ordered to accompanying Printer Control Number 1 because each Selective Tape Listing feature requires a Selective Tape Listing Control on the 2821.

Similarly, a Universal Character Set Adapter must be specified for each printer (1403-2, 1403-3, or 1403-N1) that is to have the Universal Character Set feature.

A 2540 compatibility attachment is required on IBM 2821 Models 1, 4, and 5 if the card read-punch attached to these models is to function with a System/360 Model 30 or 40 that is operating in the 1401, 1460 compatibility or 1620 compatibility mode.

DATA MOVEMENT

Data is transmitted to the IBM 2821 Control Unit from the processing unit for punching or printing, and from the control unit to the processing unit when cards are read. The data is buffered on a record basis. A record is considered to be a complete line of print or one complete card record. However, a card record need not be a full eighty columns or a line of print need not be the full capacity of the printer.

The length of any record is determined by the byte count in the Channel Command Word (CCW) of the channel. This record length always begins with column 1 of the card (in reading and punching) or the leftmost print position of the printer when printing.

CONCURRENT OPERATION

The IBM 2821 Models 1, 3, 4 and 5 can control and handle the data-flow requirements of the attached

I/O units concurrently. Each of these input/output units may be activated or terminated by the proper channel-command or unit-status condition regardless of the progress of operation of the other units.

The 2821 contains separate, unshared control units for each attached device but uses only one adapter position on a channel.

ATTACHMENT METHOD

Connection of the control unit to the channel is through the standard I/O interface. The control unit is controlled from the processing-unit channel to which it is connected, by the sequence of signals and rules of operation specified for that channel. Card read-punches and printers are connected directly to the control unit, which in turn connects them via the standard I/O interface to either the selector or multiplexer channel.

Even though the card read-punches and printers are connected by a common control unit to the interface, these input/output devices operate logically as separate units. That is, they are selected by unique addresses and controlled by individual commands as though they were each uniquely connected to the channel.

When the control unit and the attached input/output units are connected to the multiplexer channel, they operate in multiplex (data interleave) mode or in burst mode, depending on the setting of a switch on the CE panel of the 2821. When connected to a selector channel, they always operate in burst mode. In multiplex mode, two bytes are transmitted for each channel cycle for the reader or the punch. Four bytes per cycle are sent for the printer.

When addressed through the interface, the three units appear to be in the order: first the reader, second the punch, and third the printer. That is, the reader should have highest priority, the punch next, and the printer(s) next. (This is the priority of the 2821-controlled I/O units considered as a subgroup on the channel.) When a control unit is addressed by the channel, up to 1.8 us delay occurs in propagating the interface sequence while the 2821 determines if the address applies to a device connected to it.

2821 SWITCHES

Control Panel Meter Switch

The meter switch, when turned on, allows the control unit to function with its attached input/output devices and with the channel.

Use Meter (2821)

The 2821 meter runs with the coincidence of the following:

1. The presence of the metering-out signal from the CPU. The channel transmits the metering-out signal to each control unit when the CPU meter is recording processing unit time. Metering-out provides for use-meters to register time in each control unit that is not in the disabled state.
2. The presence of an interlocked condition that occurs when the 2821 meter switch is in the on position and the clock-out signal from the CPU is down. The clock-out signal down indicates that the CPU is in either a stop or wait condition.

The interlocked condition is lost with the coincidence of the following:

1. The 2821 meter switch is in the off position.
2. Absence of the clock-out signal from the CPU.
3. All devices controlled by the 2821 are in a not busy state.

When the interlocked condition is lost, the 2821 and attached devices cannot operate with the CPU.

CE Panel Mode Switch

This switch determines which mode of operation is to be used by the 2821 and all attached units. If the switch is placed in the "burst" position, all devices transfer data in burst mode. If the switch is placed in the "1 byte" position, all devices attached to the 2821 transfer data in multiplex mode. If the switch is placed in the "2-4 byte" position, all devices transfer data in multiplex mode, but the 2540 transfers 2 bytes each time it is selected and the printer 4 bytes each time it is selected. The "2-4 byte" position normally allows faster operation of the attached units than is possible in "1 byte" mode. In some programming situations, this mode may cause overrun errors to occur, because the 2821 occupies the channel while transferring the extra bytes. Note that when the 2821 control unit is attached to a selector channel, the channel forces the burst mode regardless of the position of this mode switch.

DATA CODES

The data codes used are discussed with each input/output unit description in this publication. All necessary translations of bit-patterns to or from the processing-unit bit-patterns required by any input/output unit are performed in the control unit.

BUFFERING

Enough control-unit buffering is available to contain two complete card images (80 columns of 12 bits each) and one maximum print line for the attachable printer. The maximum record sizes handled for the input/output units are:

- Card reader 80 columns, 12 bits each plus parity
- Card punch 80 columns, 12 bits each plus parity
- Printers 132 positions, 7 bits each (basic) including parity.

The 6 data bits (plus 1 additional for parity) for the printer is the bit pattern translated from the processing-unit storage byte.

A 9-bit byte received from processing-unit storage for punching is translated into EBCD (Extended Binary Coded Decimal) Card Code and stored in the control-unit punch buffer. In reading from cards, the image of each card column is read into the buffer. This EBCD Card Code is then translated to the 9-bit EBCD CPU Code (when reading out of the buffer) and sent to the processing unit.

The only restriction placed on hole patterns in any card column is that no more than one punch may occur in rows 1 through 7 of any card column (for an exception refer to the Data Mode 2 section of this publication). All other punch combinations are valid (Figure 4).

SYSTEM RESET

A system reset is initiated when the system-reset button (on the processing-unit console) is pressed. Basically, this reset is the same as the one that occurs when the system power-on key is pressed (for example, all CPU hardware registers are reset to off). However, the 2540 ready and end-of-file lights are not reset by pressing the system reset button. Note, however, that they are set to off during the system reset that occurs when the system power-on key is pressed.

A system reset applies only to devices that are on-line. This reset should be given only when the devices are not in mechanical motion. If devices are in mechanical motion when system reset is given, the results are unpredictable and a system reset could cause errors that might not be detected.

If there is any doubt about the status of the devices at the time the reset is given, operations with the 2821 should be terminated. The program should then revert to the last checkpoint applicable to the devices controlled by the 2821.

Bit Positions

4567	01				01				10				11			
	00	01	10	11	00	01	10	11	00	01	10	11	00	01	10	11
0000	T09 18	TE9 18	E09 18	TE09 18		T	E	TE0	T0 18	TE 18	E0 18	TE0 18	T0 18	E0 0	0 28	0
0001	T9 1	E9 1	09 1	9 1	T09 1	TE9 1	0 1	TE09 1	T0 1	TE 1	E0 1	TE0 1	T 1	E 1	E09 1	1
0010	T9 2	E9 2	09 2	9 2	T09 2	TE9 2	E09 2	TE09 2	T0 2	TE 2	E0 2	TE0 2	T 2	E 2	0 2	2
0011	T9 3	E9 3	09 3	9 3	T09 3	TE9 3	E09 3	TE09 3	T0 3	TE 3	E0 3	TE0 3	T 3	E 3	0 3	3
0100	T9 4	E9 4	09 4	9 4	T09 4	TE9 4	E09 4	TE09 4	T0 4	TE 4	E0 4	TE0 4	T 4	E 4	0 4	4
0101	T9 5	E9 5	09 5	9 5	T09 5	TE9 5	E09 5	TE09 5	T0 5	TE 5	E0 5	TE0 5	T 5	E 5	0 5	5
0110	T9 6	E9 6	09 6	9 6	T09 6	TE9 6	E09 6	TE09 6	T0 6	TE 6	E0 6	TE0 6	T 6	E 6	0 6	6
0111	T9 7	E9 7	09 7	9 7	T09 7	TE9 7	E09 7	TE09 7	T0 7	TE 7	E0 7	TE0 7	T 7	E 7	0 7	7
1000	T9 8	E9 8	09 8	9 8	T09 8	TE9 8	E09 8	TE09 8	T0 8	TE 8	E0 8	TE0 8	T 8	E 8	0 8	8
1001	T9 18	E9 18	09 18	9 18	T 18	E 18	0 18	18	T0 9	TE 9	E0 9	TE0 9	T 9	E 9	0 9	9
1010	T9 28	E9 28	09 28	9 28	T 28	E 28	TE	28	T0 28	TE 28	E0 28	TE0 28	T09 28	TE9 28	E09 28	TE09 28
1011	T9 38	E9 38	09 38	9 38	T 38	E 38	0 38	38	T0 38	TE 38	E0 38	TE0 38	T09 38	TE9 38	E09 38	TE09 38
1100	T9 48	E9 48	09 48	9 48	T 48	E 48	0 48	48	T0 48	TE 48	E0 48	TE0 48	T09 48	TE9 48	E09 48	TE09 48
1101	T9 58	E9 58	09 58	9 58	T 58	E 58	0 58	58	T0 58	TE 58	E0 58	TE0 58	T09 58	TE9 58	E09 58	TE09 58
1110	T9 68	E9 68	09 68	9 68	T 68	E 68	0 68	68	T0 68	TE 68	E0 68	TE0 68	T09 68	TE9 68	E09 68	TE09 68
1111	T9 78	E9 78	09 78	9 78	T 78	E 78	0 78	78	T0 78	TE 78	E0 78	TE0 78	T09 78	TE9 78	E09 78	TE09 78

Notes: T = Twelve Zone
E = Eleven Zone

Figure 4. Extended Binary Coded Decimal Card Code to Extended Binary Coded Decimal Interchange Code

MALFUNCTION RESET (SELECTIVE RESET)

Malfunction reset is initiated by the channel. Therefore, the problem programmer need not be concerned with malfunction reset. Malfunction reset is used to disconnect the I/O device from an active working condition with the channel.

If the device is not in mechanical motion when malfunction reset is given, all command and sense and status information are reset.

If, however, the device is in mechanical motion at the time malfunction reset is given, all sense and status information except busy are reset. When the device has arrived at a normal stopping point, device-end is turned on. Upon acceptance of this device-end by the channel, busy is reset and the device is free to accept another command.

INTERFACE DISCONNECT

Interface disconnect is initiated by the Halt I/O instruction. When the Halt I/O is given, the device is disconnected from the channel.

If Halt I/O is given after initial selection but before the normal channel-end, channel-end is turned on. However, if Halt I/O is given between channel-end and device-end, no additional status is generated and the device remains busy until device-end status is accepted. (Any chaining is, however, terminated.)

If a Halt I/O is issued when the device is not busy, no status is generated and the device remains not busy.

PREFERRED ADDRESSES

IBM 2821 Control Units are now shipped with the following preferred addresses prewired:

<u>Device</u>	<u>Hexadecimal Address</u>
2540 Reader	0C
2540 Punch	0D
First 1403	0E
Second 1403	0F
Third 1403	10

If two 2540's are on the same channel (two 2821's are used), the preferred address is 12 for the second 2540 Reader and 13 for the second 2540 Punch. These addresses may be altered at installation, if necessary, by the customer engineer. However, if possible, the preferred addresses should be used.

SPECIAL FEATURES CONTROLLED

Special features, which are described in other sections of this publication, are:

1. 2540
 - a. Compatibility Attachment
 - b. Punch-Feed Read
 - c. Column Binary (Data Mode 2)
 - d. 51-Column Card Handling.
2. 1403
 - a. Universal Character Set
 - b. Selective Tape Listing Features
 - c. Interchangeable Chain Cartridge Adapter
 - d. Auxiliary Ribbon Device Feature
 - e. .079-Inch High Type.
3. 1404
 - a. Interchangeable Chain Cartridge Adapter
 - b. Read Compare.
4. 2821 - Two Channel Switch.

Note that these features do not necessarily apply to all models of the device for which they are listed. Refer to the descriptions for operational and model-dependent restriction considerations.

CUSTOMER ENGINEERING CONTROL PANEL

A connector is provided for attaching a portable customer engineering control panel to the control unit. This panel helps the Customer Engineer to service the control unit.

IBM 2540 CARD READ-PUNCH

The IBM 2540 Card Read-Punch (Figure 5) is used with the IBM 2821 Control Unit.

The 2540 has a maximum reading speed of 1000 cards per minute, and a maximum punching speed of 300 cards per minute. The read and punch feeds are completely separate and operate independently.

The 2540 has five stackers each with a capacity of 1350 cards. Cards are program-directed into the appropriate stacker. Two stackers (R1 and R2) are reserved exclusively for the reader, two (P1 and P2) are used for the punch only, and one stacker RP3 can be used by either the reader or the punch. All punched cards that show an error on hole-checking after punching are automatically selected into the P1 stacker.

Note: Refer to the IBM 2540 Card Read-Punch, Form A21-9033, for 2540 restart procedures.

Addressing

Prior to any command or control operation, the channel selects the reader or the punch by sending the appropriate address to the control unit.

The address bytes received by the control unit for the reader or the punch (there is a separate address for each) consist of eight bits plus a parity bit. The bit configurations of these addresses are set in the control unit by the Customer Engineer at installation by modifying a pluggable circuit card for each device. (See the Preferred Addresses section.)

IBM 2540 READER - METHOD OF OPERATION

Operation of the reader Start key initiates three card-feed cycles if all of the following conditions exist:

1. No cards are in the read feed.
2. No cover interlock is open.
3. No stacker-full switch is operated (either punch or reader).
4. Cards are in the reader file-feed or hopper, and the reader-hopper joggler plate is in its operated position.

The three cards are fed in so that the first card stops at the pre-stacker position. Also, the reader Ready light turns on.

As the card passes the second read brushes, data read from the card enters the control-unit buffer in card-image form. That is, the bits set into the buffer correspond to the hole-patterns read from the card. Translation to the appropriate bit-pattern occurs when the data is transferred to the channel. A not-read-to-ready device-end is set on in the 2821 for the reader. The 2821 attempts to present this device-end to the channel. If the device-end is cleared by an I/O interruption or Test I/O instruction, commands can then be directed (via a Start I/O) to the reader. If this device-end is not cleared by the CPU before a Start I/O is initiated for the reader, the 2821 returns device-end plus busy-status to the channel during the Start I/O selection sequence. This clears the device-end status. Another Start I/O must then be processed to initiate any command operation for the reader.

A read command can now be acted upon. If the read command is sent, the card data from the buffer is sent to the processing unit. A stop may be sent from the channel before the buffer is empty, in which case transmission of data stops. (The stop referred to is implemented by the CCW data count going to zero before the end of buffer is reached. That is, the initial CCW count is less than 80.)

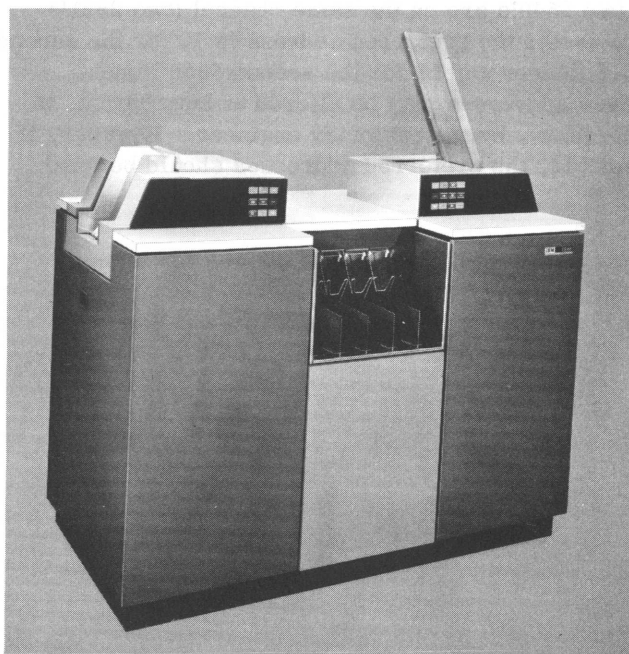

Figure 5. IBM 2540 Card Read-Punch

Channel-end is sent from the control unit in response to the CCW data count going to zero (when data chaining is not indicated) or when the transfer reaches the end of the buffer, whichever occurs first. For example, column one of the card might be read to determine in what mode (Data Mode 1 or Data Mode 2) the card should be read. A stop is sent after only one column is read. (The count of the first CCW is 1 in this case.) Programming determines, from the column-one data, the mode to be used. Programming could dictate reading the entire card in the appropriate mode; the operation would normally then be stopped at the end of buffer.

In the case of a read command without a feed and stacker-select, device-end is sent to the channel along with channel-end. If the read command includes a feed, device-end occurs when the feed is completed (at which time the buffer contains the new data).

A control command is used after a read command (which did not contain a feed and stacker select) to read the next card into the buffer. This command enables the programmer to stacker-select a card according to the information read from that card. In this particular operation, channel-end is sent to the channel immediately following the acceptance of the command byte. All necessary information, however, is contained in the modifier bits of the command. A device-end is presented to the channel when the feed is complete. (The buffer then contains the new data.)

During a feed and stacker-select operation, the card stacked is the one containing the last data transferred to the processing unit.

A read following a read with no intervening feed can be executed, but a unit-check is sent to the channel with channel-end. The unusual-command-sequence sense bit is set for this condition.

Hole-count information for each of the eighty brushes is generated and stored as the card feeds through the first read station. The hole count obtained at the second read station during the next card cycle is compared to that stored on the previous cycle. Failure to compare in any column causes an error indication and stores this error indication in the check planes. A unit-check accompanies the channel-end of the next read command to indicate this error condition.

IBM 2540 PUNCH – METHOD OF OPERATION

Operation of the punch Start key initiates two card-feed cycles if all of the following conditions exist:

1. No cards are in the punch feed.
2. No cover interlock is open.

3. No stacker-full switch is operated (either punch or reader).
4. Cards are in the punch hopper.

The two cards are fed in so that the first card is at the prepunch station. A not-ready-to-ready device-end is set on in the 2821 for the punch. The 2821 attempts to present this device-end to the channel. If the device-end is cleared by an I/O interruption or Test I/O instruction, commands can then be directed (via a Start I/O) to the punch. If this device-end is not cleared by the processing unit before a Start I/O is initiated for the punch, the 2821 returns device-end plus busy-status to the channel during the Start I/O selection sequence. This clears the device-end status. Another Start I/O must then be processed to initiate any command operation for the punch.

After initial run-in, a write command allows the channel to transmit bytes and fill the buffer. A stop can be sent before the buffer is full to punch partial cards. (The stop referred to is implemented by the CCW data count going to zero before the end of buffer is reached. That is, the initial CCW count is less than 80.) The following columns are then blank. Channel-end is presented to the channel after the CCW count goes to zero (and data chaining is not indicated) or when the punch buffer is full. The contents of the buffer are now punched into the card at the punch station, and the preceding card is fed through the punch-check station and stacked in the pocket indicated by the modifier bits of the previous write command. After punching is completed, a device-end is presented to the channel.

As the card is punched, hole-count information for each of the eighty columns is generated and stored. On the next card cycle, the hole counts obtained at the punch-check-brush station are compared with those stored from the previous cycle. Failure to compare in any column indicates an error and causes this error indication to be stored in the check planes. Both the card in error and the card after it are stacked automatically in the P1 pocket for any equipment check (except those that occur on a PFR read command). A unit-check (caused by an equipment-check sense bit) accompanies the device-end to indicate this error condition.

IBM 2540 Punch-Feed-Read – Method of Operation

The PFR (Punch-Feed-Read) special feature on the punch can be used for card reading, with or without card punching, concurrently with card reading in the read feed. Data read from the punch-feed-read and data sent to the punch both pass through a common buffer. Therefore, when it is desired to read

in the punch feed, a read must be given to the punch unit before a punch cycle is initiated by a write command in order to avoid loss of the read data.

Operation of the start key makes the machine ready if conditions warrant (see preceding section) and causes a run-in of the first card past the PFR read station. A device-end interruption is initiated. As the card passes the PFR read station, data is read into the buffer. The card then comes to rest in the prepunch station. A read command causes the buffer data to transfer to main storage. As a result of a CCW data count going to zero (no data chaining indicated) or a buffer being empty, channel-end and device-end are sent to the channel. A PFR write, feed and stacker-select command then causes the buffer to be filled by bytes transmitted from the channel across the interface. Again, a partial transfer is possible by a stop (from the CCW count going to zero when data chaining is not indicated) responded to in turn with channel-end. All the cards in the punch feed are then fed and an interleave operation of buffer unloading to the punch, and buffer loading from the read station, occurs. Thus, after the first card is completely punched, the second card is read concurrently and the buffer holds the information from the second card at completion of the operation. A device-end signal is transmitted to the channel, ending that cycle, and a new read command can then be given to repeat the process.

A read command following a read command, with no intervening write command, is executed, but a unit-check is sent to the channel with channel-end. The unusual-command-sequence sense bit is set as a result of this action.

A hole count is generated and stored from the punch-feed-read brushes and is combined with the hole count generated while punching the card. This total hole count is compared with the hole count read at the punch-check-brush station. The hole count generated at the punch-feed-read brushes is combined with the hole count generated at the punch station only if a write command is given causing the punch-feed-read data to be transferred from the card to the PFR buffer.

TERMINATION OPERATIONS

If the end-of-file key is operated (for the card reader), cards continue to feed after the hopper empties. After the last card has been read from the buffer and stacked in the selected stacker, unit-exception status is given at initial selection of the next read command. If the unit is equipped with the 2540 compatibility attachment feature and the last card is read with a compatibility command, unit-exception is given at channel-end of that command.

The reader is then in a not-ready condition after status has been accepted by the channel. It must be returned to a ready condition before further commands can be accepted.

If the end-of-file key (provided for the punch only, if the PFR feature is used) for the punch is pressed, the next valid read command (following the command used to read last-card data from the buffer) causes a unit-exception status indication at initial selection. If additional read commands are given without an intervening write, feed, and stacker-select command, unit-exception status continues to be given at each initial selection.

When unit-exception status is indicated for a read command (with PFR), a card is still at the pre-check station. Here, a write command (either for PFR or a normal write command) must be given (codes to be sent can be blank codes) so that the last card is check-read and stacked. The device-end, given after this last write command, is accompanied by unit-check status if a check condition occurred during execution of this last write command. The punch is then in a not-ready condition. It must be made ready to respond to subsequent commands.

If the end-of-file key has not been operated and the last card is fed from the hopper:

1. The ready light on the affected unit (reader or punch) goes out.
2. Place cards in the empty hopper.
3. Press the start key.
4. The ready light should turn on.

Whenever either the reader or punch is made ready, a not-ready-to-ready device-end is presented, for the affected device, to the channel. This device-end must be cleared (by an I/O interruption or a Test I/O or Start I/O instruction) before an operation with that device can be initiated.

OPERATION COMMANDS

To save channel time and main-storage space, setting up specific data modes is accomplished by modifier bits in the eight-bit command byte of the CCW rather than by separate control codes.

In the following descriptions, the type-letters for each command establish sequences for the commands that can be given. The first letter of a command type-code must match the last letter of the type-code of the preceding command. Otherwise, the sequence is invalid. For instance, the sequence:

Type AA
Type AB
Type BA

is valid, while

Type AA
Type BA

is invalid. This sequence rule has two exceptions:

1. The succession of two read and no stacker-select commands (type AB), and
2. A read and no stacker-select command (type AB) followed by a read, feed, and select-stacker (type AA) command.

In either of these two cases the commands are executed, but the unit-check status (bit 6) and the unusual-command-sequence sense (bit 6) bits are set on.

Also, the first command to the reader, after initial run-in, should be a read. (However, a sense, test I/O, or no-op command can be given.) If a feed and stacker-select command is given just after initial run-in, it is rejected.

To stack a card as a result of the data read from that card, first give a read and no feed or stacker-select command. The information can then be processed and the decision as to where to stack the card can be made. Then a feed and stacker-select command should be given to send the card to the appropriate stacker.

Note that in the following command descriptions, the C in the 2-bit position indicates Data Mode 1 if a 0, and Data Mode 2 if a 1. Reading is done only in Data Mode 1 for any punch-feed-read read operation (the 2-bit position is ignored). If the column binary (feature is not installed, operation is in Data Mode 1 regardless of the bit-3 value.

Incorrect-Length Record Considerations

A maximum of 80 bytes can be transferred for any command specifying Data Mode 1. For Data Mode 2 commands, however, two bytes are transferred for each card column, but only if the column-binary feature is installed. Therefore, a maximum of 160 bytes (specified by the CCW data count of 160) can be transferred for a column-binary operation.

The first byte for a column-binary data transfer pertains to the top half (punch positions 12 through 3) of card column one; the second byte pertains to the bottom half (punch positions 4 through 9) of card column one; the third byte pertains to the top half of card column 2; and so on. Therefore, when an odd number of bytes is to be transferred in a column-binary operation, the last byte pertains to the top half of the last card column used.

If less than 160 byte-transfers are required, the SLI (Suppress Length Indication) flag should be on in the command being executed (whose data count is initially less than 160) to avoid an incorrect-length indication. (The comparable CCW data count in Data Mode 1 is 80.) If data chaining is used, the last CCW in the chain should have its SLI flag on, to avoid an incorrect length indication, if the total number of bytes transferred to or from the 2540 for the chain is less than the maximum record size (i.e., 80 bytes in Data Mode 1, 160 bytes in Data Mode 2).

If Data Mode 2 is specified in a read command and the column-binary feature is not installed, the command is accepted and executed in Data Mode 1. However, if column binary cards (with more than one punch in card rows 1 through 7 of any single card column) are then read:

1. Unit-check status is indicated with channel-end, and
2. Sense bit 4 (data check) is set on.

If Data Mode 2 is specified in a write command and the column-binary feature is not installed, punching occurs in Data Mode 1. Note also that if the data count in any CCW is greater than 80, an incorrect-length indication is in the channel status stored in the CSW for:

1. Any command specifying Data Mode 1, and
2. Any command specifying Data Mode 2 when the column-binary feature is not installed.

A CCW data count greater than 160 causes the incorrect-length indication for a Data Mode 2 operation.

The incorrect-length indication is not given if the SLI flag is on in the CCW specifying a count greater than 80 (or 160 in Data Mode 2). However, if a CCW (with its data chain flag on) specifies a count greater than the maximum record size (80 or 160, depending upon mode), the incorrect-length indication is given regardless of the setting of the SLI bit.

Read Feed and Select Stacker (Type AA)

<u>Stacker</u>	<u>Command Byte</u>
R1	00C 00010
R2	01C 00010
RP3	10C 00010

Validity

1. Valid for reader.
2. Invalid for punch with or without PFR.

Sequence

1. Should follow a type-AA or a type-BA command.
2. Can follow a read and no feed or stacker-select (type AB) command. In this case, unit-check accompanies channel-end of the read, feed, and select-stacker (type AA) command. Unusual command sequence (sense bit 6) is indicated on a subsequent sense operation.

Action

1. Read-buffer data is sent to the channel.
2. The card, whose data is sent to main storage, is fed to the specified stacker.
3. The next-card data is read into the read buffer.

Normal Ending Status

1. Channel-end is presented to the channel after the end of data transfer (i.e., CCW data count goes to zero, or end-of-buffer is reached).
2. Device-end is presented to the channel after the end of the card-feed cycle.

Unusual Status

1. Unit exception (bit 7) at initial selection if:
 - a. End-of-file is on, and
 - b. The last card has been stacked by the preceding command.
2. Unit-check (bit 6) alone at initial selection for:
 - a. Intervention required (sense bit 1), or
 - b. Bus-out check (sense bit 2). (The command byte received at the 2821 has even parity.)
3. Unit-check (bit 6) with channel-end for:
 - a. Equipment check (sense bit 3), or
 - b. Data check (sense bit 4). This check does not occur if column binary is installed and the operation is in Data Mode 2.
 - c. Unusual command sequence (sense bit 6). (See item 2 under Sequence.)

Read and No Feed or Stacker Select (Type AB)

Command byte

11C 00010

Validity

Valid to reader or punch (with or without PFR).

Sequence

1. Should follow a type-AA or a type-BA command.
2. This command can follow itself. In this case, both commands are executed, but unit-check accompanies channel-end of the second command. Unusual command sequence (sense bit 6) is returned on a subsequent sense operation. Assume the following sequence of commands to the punch:
 - a. Write, feed, and select-stacker (type BB)
 - b. Read and no feed or stacker-select (type AB).

These commands are executed and no unit-check indication is given. However, the result is to write data into the punch buffer, punch and stack a card on the write command, and read that same data back to the processing unit on the read command.

Action

1. Buffer data (read or PFR) is sent to channel.
2. No card is fed.

Normal Ending Status

Channel-end and device-end are presented to the channel together after the end of data transfer to the channel.

Unusual Status

1. Unit exception (bit 7) for the reader at initial selection if:
 - a. End-of-file is on, and
 - b. Last card has been stacked by the preceding command.

2. Unit exception (bit 7) for PFR at initial selection if:

- a. End-of-file is on, and
- b. The last card's read data has been sent to the channel by a preceding read command.

(Note: In this case, a card is still at the pre-check station. This card can be stacked by a write, feed, and select-stacker command. Blank-data codes can be sent for this command. This operation checks and stacks the last card. Note that unit exception is given at each initial selection for read commands until the last card is stacked. After that card is stacked, the punch becomes not-ready.)

3. Unit-check (bit 6) alone at initial selection for:

- a. Intervention required (sense bit 1), or
- b. Bus-out check (sense bit 2). The command byte received at the 2821 has even parity.)

4. Unit-check (bit 6) with channel-end and device-end (they occur together) for:

- a. Equipment check (sense bit 3), or
- b. Data check (sense bit 4). This check does not occur for the reader if column binary is installed and the operation is in Data Mode 2. (PFR always operates in Data Mode 1.)
- c. Unusual command sequence (sense bit 6).

(See item 2 under Sequence.)

Read, Feed, and No Stacker-Select (Compatibility)

Command Byte

11C 10010

Validity

Valid for reader or punch (with or without PFR), but should be used for reader compatibility operation only.

Sequence

A read command must precede the next feed command after the automatic feed initiated by this command has been completed. If the automatic feed is followed by a feed and select-stacker command, unit-check (due to command reject, sense bit 0) is returned at initial selection for the feed and select-stacker command.

Action

1. Read-buffer data is sent to the channel.
2. A 6-millisecond timeout starts at the beginning of data transfer to the channel.
3. Channel-end and device-end are presented together to the channel after data transfer.
4. After channel-end and device-end are accepted, but before the 6-millisecond timeout is terminated:
 - a. Attention status (bit 0) is returned at initial selection for a sense command. (A normal sense operation is not performed; the 2821 does not send a sense byte to the channel.)
 - b. A feed and select-stacker instruction can be issued to specify into which stacker the card (whose data is sent to the channel) should be fed.
5. After the 6-millisecond timeout but before device-end for the automatic feed of this compatibility command, the 2821 responds with busy-status (bit 3) alone to any command.
6. Device-end is returned to the channel after:
 - a. The automatic feed, or
 - b. The feed initiated by a feed and select-stacker command. (Channel-end is sent to the channel at initial selection for the feed and select-stacker command if it is sent to the 2821 before the 6-millisecond timeout is terminated.)
7. The card is selected into stacker R1 if a feed and select-stacker command has been neither issued nor accepted.

(Note: Any valid command to the reader can be issued between channel-end/device-end, at the end of data transfer, and before the end of the 6-millisecond timeout. For example, assume that column binary is installed, and that the compatibility command is issued to read the card in Data Mode 1. After channel-end/device-end for the end of data transfer, a read, feed, and select-stacker command can be issued to read in Data Mode 2. Channel-end occurs after the second data transfer. Device-end then occurs after the feed.)

Normal Ending Status

See the preceding Action description.

Unusual Status

1. Unit exception (bit 7) at channel-end if:
 - a. End-of-file is on, and
 - b. The last card is read by this command.
2. Unit-check (bit 6) at initial selection for:
 - a. Intervention required (sense bit 1), or
 - b. Bus-out check (sense bit 2). (The command byte received by the 2821 has even parity.)
3. Unit-check (bit 6) at channel-end/device-end (end of data transfer) for:
 - a. Equipment check (sense bit 3), or
 - b. Data check (sense bit 4). This check does not occur if column binary is installed and operation is in Data Mode 2.

Feed and Select Stacker (Type BA)

<u>Stacker</u>	<u>Command Byte</u>
R1	00100011
R2	01100011
RP3	10100011

Validity

1. Valid for reader.
2. Invalid for punch (with or without PFR).

Sequence

1. Should follow a type-AB or a type-BB command.
2. Cannot be the first command to the reader after initial run-in.

Action

1. The card stacked is the one whose data was sent to the channel on the preceding read command.
2. The data from the card passing the read station is read into the read buffer.

Normal Ending Status

1. Channel-end is presented to the channel at initial selection (command immediate).

2. Device-end is presented to the channel after card reading (into the read buffer) is completed.

Unusual Status

1. Unit-check (bit 6) at initial selection for:
 - a. Intervention required (sense bit 1), or
 - b. Bus-out check (sense bit 2). (The command byte received by the 2821 has even parity), or
 - c. Command reject (sense bit 0). The command is issued to the punch (with or without PFR); the command is the first to the reader after initial run-in; or, this command does not follow a type-AB or a type-BB command.
2. Unit-check (bit 6) does not occur with channel-end or device-end for this command.

PFR Write, Feed, and Select-Stacker (Type BA)

<u>Stacker</u>	<u>Command Byte</u>
P1	00C01001
P2	01C01001
RP3	10C01001

Validity

1. Valid for the punch (with or without PFR).
2. Invalid for the reader.

Sequence

Should follow a type-AB or a type-BB command.

Action

A. Not compatibility mode

1. First command after initial run-in:
 - a. Data is sent from the channel to the punch buffer.
 - b. The data sent from the channel is punched (from the buffer) into the card at the punch station.

- c. Stacker selection specified by this command pertains to the card that is being punched. This stacker-select information is retained so that, on the next feed cycle, the card is stacked in the selected stacker.

2. Other than first command after initial run-in:

- a. Data is sent from the channel to the punch buffer.
- b. This data sent from the channel is punched in the card at the punch station.
- c. Stacker selection specified by this command pertains to the card that is being punched.
- d. The card punched by the preceding command is stacked as specified by that preceding command. If, however, the data read at the punch-check station does not compare with the total hole count from the data punched and the data read at the PFR brushes, that card is stacked in P1.

B. Compatibility mode

Operation is the same as in non-compatibility mode except that the stacker selection specified by the command pertains to the card punched during the preceding command.

- C. If PFR is installed, an interleaving operation occurs: data to be punched is read out of the punch buffer to the punch circuitry to cause punching; data is read from the next card by the PFR brushes into the punch buffer. At completion of punching, the punch buffer contains the card data read by the PFR brushes. The card read by these brushes stops at the punch station.

Operation in Data Mode 2 (if column binary is installed) pertains only to the card being punched. The card read by the PFR brushes is always read in Data Mode 1. If column binary is not installed, the card is punched in Data Mode 1 regardless of the setting of bit 2 in the command byte.

If PFR is not installed, this command functions in the same manner as the write, feed, and select-stacker (type-BB) command.

Normal Ending Status

- 1. Channel-end is presented to the channel after the end of data transfer from the channel to the punch buffer.
- 2. Device-end occurs after card punching is completed.

Unusual Status

- 1. Unit-check (bit 6) alone at initial selection for:
 - a. Intervention required (sense bit 1), or
 - b. Bus-out check (sense bit 2). (The command byte received at the 2821 has even parity), or
 - c. Command reject (sense bit 0). This command is sent to the reader, or this command follows a type-BA or a type-AA command.
- 2. Unit-check (bit 6), channel-end, and device-end are presented together for:
 - a. Bus-out check (sense bit 2). Punch data sent from the channel to the 2821 has even parity. Punching does not occur and cards are not fed.
- 3. Unit-check (bit 6) is presented with device-end for equipment check (sense bit 3).

This indication specifies that the number of holes punched in the preceding card does not match the number of holes that should have been punched. Therefore, this check applies to the card punched on the preceding command. (Hole-count data from the PFR read and from the punch station are combined and compared with the punch-check-brush hole count, if PFR is installed.)

Write, Feed, and Select Stacker (Type BB)

<u>Stacker</u>	<u>Command Byte</u>
P1	00C00001
P2	01C00001
RP3	10C00001

Validity

- 1. Valid for the punch (with or without PFR).
- 2. Invalid for the reader.

Sequence

Should follow a type-AB or a type-BB command.

Action

This command functions in the same manner as the PFR write, feed, and select-stacker (type-BA) command except that card data is not read by the PFR brushes.

Normal Ending Status

The same as for the PFR write, feed, and select-stacker (type-BA) command.

Unusual Status

The same as for the PFR write, feed, and select-stacker (type-BA) command.

Sense, and No-Op

The bit structures for these commands are:

Operation Code Bits
01234567

<u>Sense</u>	00000100
<u>No-Op</u>	00000011

The sense command should have an initial data count of 1 because the 2821 returns only one sense byte for any attached device addressed for a sense operation. Channel-end and device-end status are presented to the channel by the 2821 after the sense byte is accepted by the channel. Therefore, a sense operation is not an immediate operation.

The no-op command is an immediate command. Channel-end and device-end are presented to the channel during the selection sequence for a no-op command.

Test I/O

The programmer can use the Test I/O instruction as described in IBM System/360 Principles of Operation, Form A22-6821. The channel, however, sends the Test I/O command to a device to obtain status. The bit structure for the Test I/O command is 00000000. Note that this command can be sent to a device whenever the channel requires status (i.e., such as stacked status) from that device and, hence, the Test I/O command does not depend upon execution of a Test I/O instruction. An important point to note is that you cannot use the Test I/O command byte (00000000) as an operation code in a CCW. Program-check channel status results if an attempt is made to execute a CCW whose command byte bits 4-7 = 0000. This command, then, is an internal channel function.

DATA CODES

Data Mode 1 and Data Mode 2 are under control of modifier bits in the command byte (part of the CCW).

Data Mode 1

Data Mode 1 is used when translating the Extended BCD Card Code to and from the 8-bit EBCD Interchange Code (see Figures 4 and 14).

Data Mode 2 (Special Feature)

In this mode the 12 bits from each card column are expressed as two 8-bit bytes. These bytes are composed of two zeros (bit positions 0 and 1) and 6 bits from the card-image buffer column as follows:

<u>Card Row Bit</u>	<u>Interface Bit</u>
12	2 odd byte
11	3 odd byte
0	4 odd byte
1	5 odd byte
2	6 odd byte
3	7 odd byte
4	2 even byte
5	3 even byte
6	4 even byte
7	5 even byte
8	6 even byte
9	7 even byte

This mode allows for transmitting any punched hole appearing in the card.

For punching in column binary, the bytes sent from main storage are acted upon in the following manner:

1. Bits 0 and 1 are ignored. (These two bits do participate in the parity check made on the byte, however.)
2. Bits 2 through 7 are translated to the appropriate punch combination.

Assume that reading or punching in column binary starts at column one of the card. The following relationships between punch positions and bytes transferred exists:

<u>Byte To/From</u> <u>Main Storage</u>	<u>From/To</u> <u>Card Column Punch Positions</u>	
	<u>12-3</u>	<u>4-9</u>
1st	1	--
2nd	--	1
3rd	2	--
4th	--	2
....
159th	80	--
160th	--	80

However, byte transfer can be started at any column desired. For example, if reading is to start at byte 18 and end after the 27th byte transfer of the reader record:

1. Byte 18 corresponds to punch positions 4-9 of card column 9; byte 27 corresponds to punch positions 12-3 of card column 14.
2. A read command with its data chain and skip flags and its data count equal to 17 is executed for the reader. When the data count goes to zero, the next CCW is executed by the channel.
3. This second CCW, because it is data chained, performs the same read operation, but its skip flag is off. Buffer transfer starts at byte 18. This CCW has a data count of 10. The data chain and skip flags of this CCW are off; the SLI flag is on so that an incorrect-length indication can be avoided.
4. When the data count goes to zero, the channel specifies to the 2821 that data transfer should stop.
5. The 2821 presents channel-end to the channel.

Note that the operation cannot be performed in the same way for the punch, because the CCW skip flag pertains to input operations only. The same operation could be performed for the punch in the following manner.

1. A write command executed for the punch has:
 - a. The SLI flag on.
 - b. A data count of 27.
2. The punch record in main storage has:
 - a. bytes 0 through 17 all set to zero.
 - b. bytes 18 through 27 set to the desired bit combinations.
3. After the CCW data count goes to zero, the channel specifies to the 2821 that data transfer should be stopped.
4. The 2821 presents channel-end to the channel, signifying completion of data transfer.

STATUS BYTE

The status byte indicates to the channel the condition or status of the input/output device involved (i. e., 2540 reader or 2540 punch). With the exception of busy and unit-check (caused by an intervention-required), these bits are reset in the control unit when they have been accepted by the channel. The unit-check caused by intervention-required is reset only after the intervention-required condition has been corrected.

Busy is reset only after device-end for an operation is cleared. If the device-end is cleared by a Start I/O, busy accompanies device-end in the CSW stored for the Start I/O operation. Busy is not indicated in the CSW stored as a result of executing a Test I/O to a device with outstanding status. If the device is busy performing an operation (device-end for the operation has not yet occurred) when it is addressed for execution of the Test I/O instruction, the condition code is set to 2 and a CSW is not stored.

Busy status is in the CSW, stored as a result of execution of a Test I/O instruction for the reader (or the punch) only if:

1. Channel-end for the current operation at the device has already been cleared at the channel (via an I/O interruption or previous Test I/O),
2. The reader (or punch) is finishing the mechanical portion of the operation, and
3. Device-end has not yet been set on in the 2821 for the operation.

Bit 0 – Attention

This bit is not used except when the 2540 Compatibility Attachment is used. Refer to the Read, Feed, and No-Stacker-Select Command description.

Bit 1 – Status Modifier

Bit 2 – Control Unit End

Bits 1 and 2 are not used except in two-channel switch operations. (See the Two-Channel-Switch Special Feature section.)

Bit 3 – Busy

Busy status is given only at initial selection and indicates that the device cannot execute the command because a previously initiated operation is being executed or because an interruption condition exists. An operation is being executed from the time that status (at initial selection) is accepted until device-end is accepted.

The interruption condition is caused by an outstanding channel-end, device-end, or any status being stacked at the 2821 for the addressed unit.

If the device is in the busy condition, no status bits, other than busy, are presented to the channel unless the interruption condition is present.

Bit 4 – Channel-End

This bit indicates that data transfer, if any, over the interface has been completed. The data transfer is completed at the end of the maximum record size for the operation (80 bytes normal record, 160 bytes in column binary), or when the channel specifies that the operation should be stopped (CCW data count has gone to zero).

Bit 5 – Device-End

This bit indicates that either the reader or the punch has either completed the previous command or has just been placed in ready state. The device is free to accept a new command.

The 2821 attempts to present device-end (for the appropriate unit) to the channel, when the reader or the punch is made ready. This status must be accepted by the channel before an operation for the 2540 can be initiated.

Bit 6 – Unit Check

This bit indicates that the reader or punch requires program or operator intervention. It is a summary of sense bits 0, 1, 2, 3, 4, and 6.

Bit 7 – Unit Exception (End-of-File)

This bit pertains to the reader or PFR and indicates that the last card has been read and stacked in the reader, or read but not stacked in the punch. This can occur only if end-of-file is on.

SENSE BYTE

Except for intervention required, all bits for a device are reset by acceptance of any new command to that device other than Sense, Test I/O, or No-Op.

Bit 0 – Command Reject

For the reader, this bit indicates that a read-backward or write command was received. For the punch, it indicates that a read-backward, control (other than no-op), or read and stacker-select command has been received by the punch.

The sequence of commands must follow the sequence rule to be valid. (See the specific command descriptions for details concerning when command reject is set for sequence-rule violations.)

If the column-binary feature is not installed, commands with bit 2 on in the command byte are executed in Data Mode 1.

A PFR write, feed, and select-stacker command is valid for the punch whether or not the PFR feature is installed.

The two-channel switch commands are not valid and cause a command-reject indication if the two-channel switch feature is not installed. (This feature is for 2821's attached to the System/360 Model 67 only. See the Two-Channel Switch section for further details.)

Except for the deviations just described, any operation-command bit structure not defined in this publication causes the command-reject indication if that command is sent to the 2821 for the reader or the punch.

Bit 1 – Intervention Required

This bit indicates that some type of operator intervention is required. That is, a stacker has become full, the chip box has become full or is missing in the punch, a card jam has occurred, the unit has not been placed in the ready condition, or an empty-hopper condition exists. This bit, when on, does not cause a unit-check status response to a sense command. It is reset when the causing condition is corrected.

Bit 2 – Bus-Out Check

This bit indicates that a parity error has occurred on bus-out on a command or data byte (bus-out is a data transfer from the processing unit to the control unit). This includes parity errors detected when data is transmitted across the standard I/O interface during a write command to a buffer. If such parity errors are detected, punching does not occur and channel-end is then indicated with device-end and unit-check. In this case, card feeding does not occur.

Bit 3 – Equipment Check

This bit indicates:

1. A translate check. This occurs if the translation from punched-card code to processing-unit code (or processing-unit code to punched-card code) has not been performed correctly in the 2821.
2. A buffer-address check. This occurs if the circuitry that addresses the punch or reader buffer operates incorrectly.
3. A data-register parity error. This parity check can occur for any data byte read from or written into either the punch or reader buffer in the 2821.
4. Hole-count error. This is indicated if the holes actually punched in a card (or read from a card) do not match the number of holes that should have been punched (or should have been read at the read brushes).

In the reader, unit-check for this indication is sent only at channel-end for a read command, and applies only to the card for which data is transmitted on the read. In punching, the unit-check indication is sent only with device-end on a write command, and applies to the previous card punched. Also, when punching, the unit-check may be sent with channel-end if channel-end status has not been accepted within

170 milliseconds after completion of data transfer. If this occurs, the unit-check indication is also sent with device-end.

For PFR only, a translate check or data-register parity check affecting the data transmitted is indicated by unit-check with channel-end on the read command; the hole-count check is indicated by unit-check with device-end on the second write command.

Bit 4 – Data Check

This bit indicates that an invalid card code has been detected in the reader or in the punch (if the PFR feature is installed). This indication occurs with channel-end on a read command for both the reader and the punch (with PFR) and pertains to the card for which the data was sent. It indicates that more than one punch exists in rows 1 through 7 of a card column. This check is not operative when Data Mode 2 is used. Data Mode 2, however, is not used for PFR read operations.

Bit 5 – Overrun (Not Used)

Bit 6 – Unusual Command Sequence

On the reader or PFR this indicates a read following a read with no intervening feed. Both read commands, however, are executed. (Unit-check is presented with channel-end of the second read command.)

STATUS BYTE BIT COMBINATIONS

Bit positions shown for status combinations are in the following order:

0 1 2 3 4 5 6 7

Note that these are status combinations that are presented to the channel from the 2821. For further information as to how status is placed in the CSW (channel status word), refer to IBM System/360 Principles of Operation, Form A22-6821.

1. 0 0 0 0 0 0 0 0

Normal response to a valid command with odd parity when the device is ready but not busy. This response indicates that the command was accepted.

Note: Even if the device is not ready, a sense command is accepted and this status is given.

2. 0 0 0 0 0 1 0 0

Indicates that:

- a. An operation involving mechanical motion has been completed, or
- b. The device has gone from the not-ready to ready state.

This combination is given only in response to a Test I/O, or when presenting status in a sequence initiated by the 2821.

3. 0 0 0 0 0 0 1 0

Occurs only at initial selection (if this status is not stacked on a previous sequence). This combination indicates that the device could not accept the command because of sense bits 0, 1, or 2.

Note: This same status could be presented in a sequence initiated by the 2821, or in response to a Test I/O if the status is first stacked by the channel during initial selection.

4. 0 0 0 0 0 0 0 1

Occurs first at initial selection in response to a read command to the reader or punch (with PFR), and indicates that the last card in the hopper has been read (data sent from buffer) and stacked in the reader, or read but not stacked in the punch. This same status could be presented in a sequence initiated by the 2821, or in response to a Test I/O, if it had first been stacked by the channel during initial selection.

This combination should never occur when operating in 1400 compatibility mode.

5. 0 0 0 0 0 1 1 0

Indicates that:

- a. A punch operation has been completed and that sense bit 3 is on, or
- b. The device has gone from the not-ready to ready state and then reverted to the not-ready state prior to the 5-bit being accepted, or
- c. Unit-check status (due to sense bit 0 or 2) was stacked by the channel, and the device went from the not-ready to the ready state prior to the 6-bit being accepted.

This combination is given only in response to a Test I/O, or when presenting status in a sequence initiated by the 2821.

6. 0 0 0 0 0 1 0 1

Should not occur.

7. 0 0 0 0 0 1 1 1

Should not occur.

8. 0 0 0 0 0 0 1 1

Should not occur.

9. 0 0 0 1 1 0 0 0

Indicates that the device is in mechanical motion but channel-end has not yet been accepted by the channel.

This combination occurs only during initial selection, when the command byte is not a Test I/O.

10. 0 0 0 1 1 1 0 0

Indicates that the device has completed an operation but channel-end and device-end status has not yet been accepted by the channel.

This combination occurs only during initial selection, when the command byte is not a Test I/O.

11. 0 0 0 1 1 0 1 0

Indicates that:

- a. Data transfer has been completed for a read, feed, and SS command.
- b. The reader is taking a feed, and
- c. Any one or more of sense bits 3, 4, and 6 is on.

This combination may also occur while punching if channel-end status had not been accepted within 170 ms after completion of the data transfer. In this case, sense bit 3 would be on.

This combination occurs only:

- a. During initial selection, and
- b. For a command other than a Test I/O.

12. 0 0 0 1 1 0 0 1

Should not occur.

13. 0 0 0 1 1 1 1 0

Same as 10 except that:

- a. One or more of sense bits 3, 4, and 6 is on for a read, or
- b. Either sense bit 2 or 3 is on for a write.

14. 0 0 0 1 1 1 0 1

This combination should not occur, except possibly in 1400 compatibility mode, where it would indicate that data transfer had been completed for a 1400 reader read command, and the last card in the hopper had been read (data sent from buffer) and stacked. If this combination occurs for the punch in compatibility mode, it indicates that the last card has been fed from the punch hopper, punched, and stacked.

This combination would be presented only at initial selection, where the command is not a Test I/O.

15. 0 0 0 1 1 1 1 1

Same as 14, except that one or more of sense bits 3, 4, and 6 is on.

16. 0 0 0 1 1 0 1 1

Should not occur.

17. 0 0 0 0 1 0 0 0

18. 0 0 0 0 1 1 0 0

17 and 18 are the same as 9 and 10, respectively, except that 17 and 18 are given only during initial selection for a Test I/O or control command, or when presenting status in a sequence initiated by the 2821.

19. 0 0 0 0 1 0 1 0

Same as 11 except that this combination is given only in response to a Test I/O or when presenting status in a sequence initiated by the 2821.

20. 0 0 0 0 1 0 0 1

Should not occur.

21. 0 0 0 0 1 1 1 0

22. 0 0 0 0 1 1 0 1

23. 0 0 0 0 1 1 1 1

Combinations 21 through 23 are the same as 13 through 15, respectively, except that 21 through 23 are given only in response to a Test I/O, or when presenting status in a sequence initiated by the 2821.

24. 0 0 0 0 1 0 1 1

Should not occur.

25. 0 0 0 1 0 0 0 0

Normal response given to any command issued to the device when that device is between channel-end and device-end.

26. 0 0 0 1 0 1 0 0

Same as 2 except that this combination occurs only:

- a. During initial selection, and
- b. For a command other than a Test I/O.

27. 0 0 0 1 0 0 1 0

Occurs only:

- a. During initial selection, and
- b. For a command other than a Test I/O.

This combination is caused by combination-3 status being stacked by the channel.

28. 0 0 0 1 0 0 0 1

Occurs only during initial selection when the command byte is not a Test I/O. This combination is caused by combination-4 status being stacked by the channel.

29. 0 0 0 1 0 1 1 0

Same as 5 except that this combination occurs only:

- a. During initial selection, and
- b. For a command other than a Test I/O.

30. 0 0 0 1 0 1 0 1

Should not occur.

31. 0 0 0 1 0 1 1 1

Should not occur.

32. 0 0 0 1 0 0 1 1

Should not occur.

Note that:

1. There should never be a combination that includes a 1 in bit positions 1 or 2. (For an exception, see the Two-Channel Switch section.)
2. There should never be a 1 in bit position 0 except as defined for 1401, 1460 compatibility mode. (Refer to the Read, Feed, and No Stacker Selection command description.)

Those combinations that should not occur do occur only as a result of a machine malfunction.

POSSIBLE COMBINATIONS OF SENSE BITS IN A SENSE BYTE

Assume, for these descriptions, that the previous command had been executed, and that the unit-check status was given with channel-end or device-end, except where noted.

<u>Previous Command</u>	<u>Sense Bits</u>
Read (reader or punch with PFR)	Any one or more of the following: B3—equipment check B4—data check B6—unusual command (and possibly B1—intervention required).
Feed and Stacker Select	Possibly B1—intervention required (the operator might have pressed the stop key). <u>Note:</u> There is no unit-check indication with channel-end or device-end for this command.
Write (assuming card had been punched, i.e., no bus-out check).	B3—equipment check (and possibly B1—intervention required).
Write (card was not punched due to bus-out check during data transfer).	B2—bus-out check (and possibly B1—intervention required).

DIAGNOSTIC COMMANDS FOR THE 2540 CONTROLS

There are three diagnostic commands for checking the 2540 controls. These commands are described here but their use is intended primarily for field engineering diagnostic tests.

Diagnostic Write (100101)

This command transmits 6 bits per byte, the same as for a column binary write. The punch translator is

bypassed and the data is stored in the read portion of the read-punch buffer. This command is addressed to the punch. However, the data is transferred to the reader buffer. Therefore, neither device should be busy executing a previous command when this command is given. No mechanical motion is associated with this command, and ending status includes both channel-end and device-end.

Bit positions 0 and 1 of the command byte must be a combination that is valid for a normal punch-write command. A normal read command allows the data written on diagnostic write to be transferred back to the CPU for analysis.

If the reader is busy when the diagnostic write command is given to the punch, the command is rejected and punch sense bit zero turned on.

If the reader is given any read or control command while the diagnostic write is being executed, the command is rejected and reader sense bit zero turned on. Sense or Test I/O commands to the reader, however, are accepted.

Diagnostic Read (11000010)

This command, when given to the reader, is identical to the normal read and no feed command. When given to the punch, this command is identical to the PFR punch read command. However, if the PFR feature is not installed, sense bits 3, 4, and 6 cannot be set as a result of this command.

The availability of the diagnostic read and write commands provides the ability to pattern exercise either the read or punch portions of the read-punch buffer. By varying the data sent to the 2821 and analyzing the data returned to the CPU, a data-path failure can be localized.

Diagnostic Check Read (11000110)

This command provides further localization of reader and punch check problems. Diagnostic check read performs a transfer of check information to the CPU. The signals returned are as follows.

<u>Bit</u>	<u>Reader</u>	<u>Punch</u>
3	XU Check Plane	XU Check Plane
4	XL Check Plane	XL Check Plane
5	Buffer Parity Check	Buffer Parity Check
6	Read Translate Check	Punch Translate Check
7	Reader Buffer Address Check	Punch Buffer Address Check

Bit 6 appears only in the first byte of the check read transfer and indicates a translate check in the previous data transfer.

Bit 7 appears in the first byte of the transfer if the error occurred on a previous cycle or if the error occurred on the first byte of transfer. It appears in succeeding bytes if the error reoccurred during the transfers. Bits 3, 4, and 5 can appear in any byte to indicate the position of error.

KEYS, SWITCHES, AND INDICATORS

Some of the keys, switches, and indicators are common to both reader and punch; some are used exclusively as shown in the following paragraphs.

Common Reader-Punch Indicators

Power Light

When on, this light indicates that dc voltage is present in the 2540.

Transport Light

This light is on when a jam is detected in the continuously running section of either the punch or read feed.

Stacker Light

This light is on when any one of the five stackers is full.

Fuse

This light indicates that a -20 volt fuse is blown in the 2540.

Card-Reader Keys and Indicators

Start Key

Pressing this key starts the motor and feeds the first card into the pre-stacker station if cards are on the file feed or in the hopper. A nonprocess runout is effected if the end-of-file light is not on, the hopper

joggler is open, the hopper is empty, and the start key is operated. The cards in the transport are then run out into stacker R1.

Stop Key

This key stops the reader motor and also resets the end-of-file condition.

End-of-File Key

Pressing this key sets up the 2540 run circuits so the last cards can be processed when the hopper becomes empty.

Feed-Stop Light

This light is on when the reader motor stops as a result of a jam, misfeed, or a card feed-clutch failure. It can be switched off only by a nonprocess runout and clearing the feed.

Reader-Ready Light

This light indicates that the reader is in ready status.

Reader Check Light

This light indicates a hole-count check, parity check, translate check, address check, or clutch failure while reading. It is turned off when a new command (other than Sense, Test I/O, or No-op) is accepted by the 2821 for the reader.

Validity Light

This light indicates that an invalid punch configuration (more than one punch in rows 1-7 of a single card column) has been detected on a Data Mode 1 read operation for the reader or for the punch (with PFR).

End-of-File Light

This light indicates that the end-of-file key has been operated. The light is turned off when unit exception status is set on for the first read command directed to the reader after the last card from the hopper has been stacked.

If, however, operation is in compatibility mode, and the last card is read with a compatibility command, unit exception occurs with channel-end for that command and the end-of-file light is turned off.

The end-of-file light also is turned off when the reader stop key is operated.

Card-Punch Keys and Indicators

Start Key

Pressing this key starts the motor and feeds the first card as far as the pre-punch station. If the hopper is empty and the start key is pressed, a nonprocess runout is initiated. The cards in the transport are then run out into stacker P1.

Stop Key

Operation of this key stops the motor at the completion of a mechanical cycle. If the PFR feature is present, pressing the stop key turns off the end-of-file light.

Punch-Ready Light

This indicates the punch is in ready status.

Feed-Stop Light

This light is on when the punch motor stops as a result of a jam, misfeed, or a punch-clutch feed failure. This light can be switched off only by doing a nonprocess runout and clearing the feed.

Chips Light

This light is on when the punch chip box is either full or missing.

Punch-Check Light

This light indicates a hole-count check, translate check, parity check, or clutch failure in the punch. It is turned off when a new command (other than Sense, Test I/O, or No-op) is accepted by the 2821 for the punch.

End-of-File Key (PFR Feature Only)

Pressing this key sets up the run circuits so the last cards can be processed when the hopper becomes empty.

End-of-File Light (PFR Feature Only)

This light indicates that the end-of-file key has been operated. The end-of-file light is turned off after the last card from the punch feed is stacked.

The end-of-file light also is turned off when the punch stop key is operated.

SPECIAL FEATURES

Punch-Feed-Read (PFR) Feature

This feature makes it possible to punch a card as the result of the data read from that card. A read station prior to the punch station reads a card, when commanded, before the card is punched on the next cycle.

Data Mode 2 - Column Binary Feature

With this feature, the reader can read directly 2 X 80 characters of six bits each into main storage by transmitting 160 bytes (eight-bit bytes, each consisting of six bits read directly from the card, plus two high-order zeros). Any punch combination can thus be read into main storage.

With this mode, the punch can punch directly 2 X 80 characters of six bits each into a card; again the two high-order bits of the internal eight-bit code are set to zero. Thus, any combination of punches can be punched. (See the Data Mode 2 (Special Feature) section.)

2540 Compatibility Attachment Feature

This feature allows for proper stacker selection on both the reader and the punch when the system is operating in compatibility mode. A description of 1400 compatibility mode for the System/360 Model 30, is given in IBM System/360 Model 30, 1401, 1440, and 1460 Basic Compatibility Feature and Subfeatures, Form A24-3255; for the Model 40, refer to IBM System/360 Model 40, 1401, 1460 Compatibility Feature, Form A22-6839.

A description of the 1620 Compatibility mode for the System/360 Model 30 is in IBM System/360 Model 30 1620 Compatibility, Form A24-3365.

51-Column Card Handling (2540 Reader Only)

With this feature, a 51-column card can be fed and read in the reader (at a maximum speed of 800 cards per minute for either 51- or 80-column cards, when the feature is installed). The 51- and 80-column cards cannot be intermixed on the same run. The data columns correspond to columns 15 through 65 of an 80-column card. Therefore, the 51 columns of data from these cards appear in buffer positions 15 through 65 and also in the same corresponding positions in the resulting main-storage record. In main storage, columns 1 through 14 and 66 through 80 receive "blank" coded characters from the reader buffer. Normally, the entire record is 80 characters long, although the programmer can stop reading at 65 columns, if desired. This feature is for the 2540 and requires no adapter on the 2821.

no cards have been fed for 30 seconds or more, the motor stops and a 500-millisecond clutch access is required on the next command.

To keep the reader running at maximum speed, a new feed command must be given after device-end but before the clutch decision point. When the feed is given with a read command, the data transfer from the buffer is completed before the clutch can be activated (Figure 6).

Card Punching

The punch allows a 50-millisecond maximum access time to the clutch. If no cards have been fed for 30 seconds or more, the motor stops and a 500-millisecond clutch access is required on the next command.

To keep the punch running at maximum speed, a new write command must be given and the data transfer completed before the clutch decision point following device-end (Figure 7).

PROGRAMMING TIMING CONSIDERATIONS

Card Reading

The reader allows for either a 25-millisecond or a 20-millisecond maximum access time to the clutch on the 800 card-per-minute (51-column interchangeable read feed feature) and 1000 card-per-minute reader, respectively. That is, if a feed order is given to the card reader immediately following the clutch decision point (Figure 6), start of feeding is delayed for 25 ms on the 800 card-per-minute reader and 20 ms on the 1000 card-per-minute reader. If

Channel-End to Device-End

The minimum time from generation of channel-end to generation of device-end is:

1. Reader
 - a. 1000 cards per minute 50 milliseconds
 - b. 800 cards per minute 63 milliseconds
2. Punch

300 cards per minute	175 milliseconds
----------------------	------------------

800 cards per minute (51-column Card Feature)

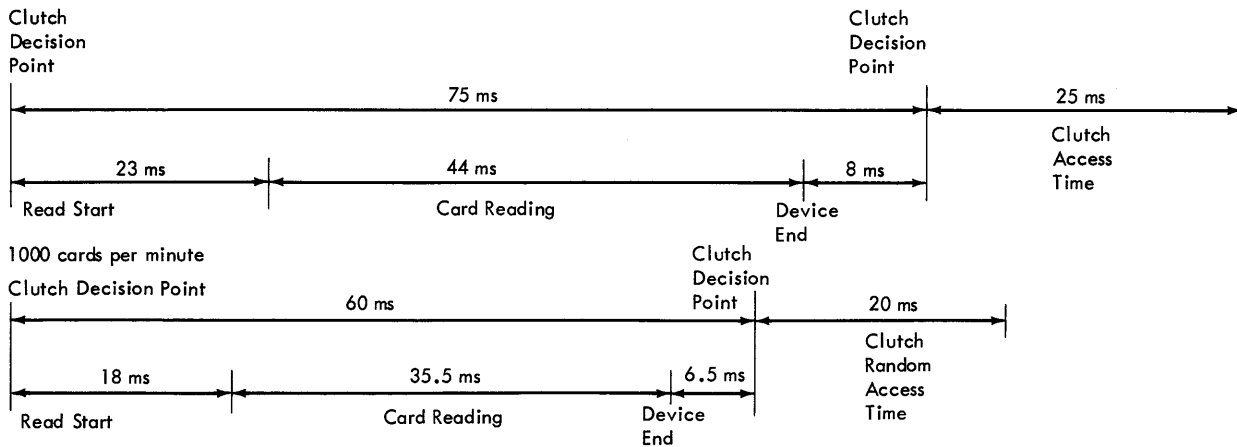

Figure 6. Card-Read Timings (2540)

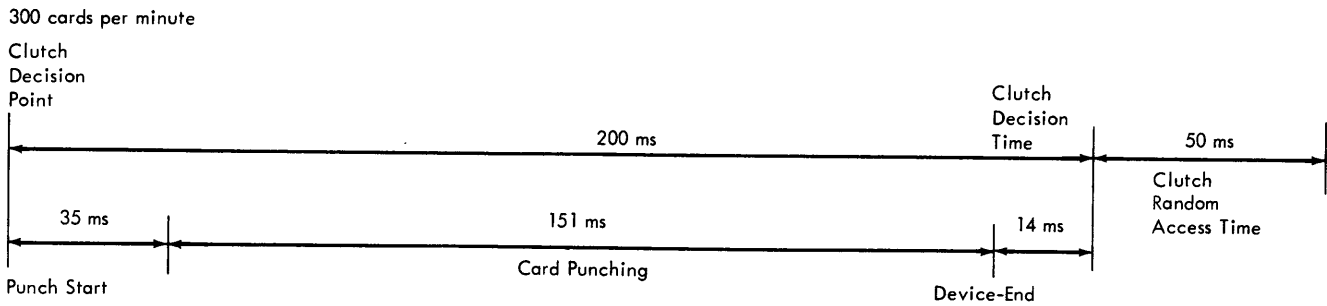

Figure 7. Card-Punch Timings (2540)

Data Transfer Rate

Data transfer time to the punch buffer and from the read buffer is 6 microseconds per byte in burst mode. On the multiplexer channel, and in byte mode, two bytes of data are sent each time the unit obtains the channel.

A similar condition exists with respect to the available time from device-end on the punch to the clutch decision point when data is transferred over the interface from the read buffer. In addition, the punch device is delayed 0.5 millisecond if the reader calls for a read scan during the last 0.5 millisecond of punch time. The maximum delays are (in milliseconds):

	<u>Burst Mode</u>	<u>Multiplexer Mode</u>
--	-------------------	-------------------------

Read (Data Mode 1)	0.5	0.5
Read (Data Mode 2)	1.0	0.5

Device-End to Clutch Decision-Point Timing

If data is transferred over the standard I/O interface to the punch buffer during the last 0.5 millisecond of card reading time, device-end (for the reader) is delayed. The available time from device-end to the clutch decision point is reduced by the amount of this delay. The maximum delays are (in milliseconds):

	<u>Burst Mode</u>	<u>Multiplexer Mode</u>
Punch-feed-read	0.5	0.5
Punch write (Data Mode 1)	0.5	0.5
Punch write (Data Mode 2)	1.0	0.5

2540 USE METER

The use meter starts recording time when the first reader or punch command is accepted. This meter continues to run as long as the 2540 is on line and the 2821 meter is recording time. The 2540 meter stops, however, after both the punch and read trans-ports are empty of cards and the last command has been acted upon. For example, the commands received by the read or punch feed, with PFR, during an end-of-file runout.

Five models of printers can be attached to the IBM 2821 Control Unit:

<u>Printer Model</u>	<u>Print Positions</u>	<u>Lines per Minute*</u>
1403-2	132	600
1403-3	132	1100
1403-N1	132	1100
1403-7	120	600
1404-2	132	600

*Without the Universal Character Set feature.

The 1404 can also print on card documents at a maximum rate of 800 cards per minute. The IBM 1403 Model N1 Printer (Figure 8) has acoustical covers that greatly reduce the sound level produced by high-speed printing operations. The upper print cover on the 1403-N1 is motor driven (to give the operator access to the forms and print train areas of the printer).

The IBM 1403-2, IBM 1403-3 (Figure 9), IBM 1403-7, and IBM 1404 (Figure 10) Printers are described in this publication relative to their use in IBM System/360. Further information about these devices is contained in IBM 1403 Printer, Form A24-3073, and IBM 1404 Printer, Form A24-1446.



Figure 9. IBM 1403 Printer

As used with IBM System/360, these printers print in the same manner (except for the character sets used), require the same ribbons and paper, and, in general, have the same carriage and features as described in associated System Reference Library publications. Except where otherwise noted, the following descriptions apply to all 1403 printers that can be attached to the 2821.

The 1403-2 and 1403-7 printers can be attached to System/360 Model 20. Descriptions of these printers as they attach to System/360 Model 20 are not contained in this publication. Refer to separate Systems Reference Library publications, as listed in IBM System/360 Model 20 Bibliography, Form A26-3565, for descriptions of I/O units attached to System/360 Model 20.

Printing Positions and Type Format

The print-line length is 132 positions (except the 1403-7, which has 120 positions) for printers described in this publication. The characters are



Figure 8. IBM 1403 Printer Model N1



Figure 10. IBM 1404 Printer

horizontally spaced ten to the inch. Vertical line spacing is six or eight lines per inch. The type is .095 inches high by .062 inches wide (also see the Universal Character Set section of this publication). The processing unit edits all printed output.

Character Sets

A 48-character set (26 alphabetic, 10 numeric, and 12 special characters) is standard. Whether the 48AN or 48HN set is printed depends on the chain or train mounted on the printer. For a more complete description of chain and train configurations, refer to the Universal Character Set section.

Tape-Controlled Carriage

The use of marginally punched continuous forms is required for normal printer operation. A tape-controlled hydraulic carriage advances the forms

according to a predetermined format. However, the operator can single-space, restore, or stop the carriage manually. Carriage-skip motion up to eight lines is accomplished at 33 inches per second. Motion beyond eight lines is accomplished in a high-speed skip mode at 75 inches per second. The 1403-7 printer, however, has a single speed carriage that operates at the 33-inches-per-second speed for all spacing operations.

Space suppression is provided to permit overprinting for accentuating titles and to facilitate plotting applications.

Code Consideration and Dualing

Figure 11 shows the characters printed from the EBCDI Code when the 48AN or 48HN chain or train is used (without the Universal Character Set feature).

Except for the exception specified in Note 3 in Figure 11, and the exception for dualing of special-character bit patterns, note that:

1. Graphic representations are undefined for the bit patterns outside the heavily lined portions of Figure 11. These bit patterns are referred to as undefined-graphic bit patterns.
2. If an undefined-graphic bit pattern is sent from main storage to the printer, some graphic will generally be printed, but the actual graphic that will be printed is not specified.
3. The graphic printed by the printer for an undefined-graphic bit pattern sent from main storage may be different than that printed (displayed, etc) by another I/O device.
4. IBM reserves the right to change at any time the graphic printed by printers attached to the 2821 for an undefined-graphic bit pattern sent from main storage.

PRINTING PRINCIPLES

Method of Printing

The alphabetic, numeric, and special characters are assembled in a moving array of type. The type travels in a horizontal plane, each character being printed as it is positioned opposite a magnet-driven hammer that presses the form against the type segment.

Hammer-checking assures that a hammer fires only when instructed.

Checking

In addition to the hammer-checking, all data transferred between the buffer and the character-compare unit is parity checked. The printer requires an odd-parity bit configuration. Checking to determine that a selected hammer magnet has been energized is a standard feature of 1403 printers, as is checking for synchronism between the type and the controls.

Addressing

Before any command is executed, the channel selects the printer by sending out the printer's address to the IBM 2821 Control Unit. The address byte of the printer is manually set by the Customer Engineer at

installation in a programmable card. The address byte contains the eight-bit binary address of the printer, plus a parity bit. (See the Preferred Addresses section.)

Method of Operation of the IBM 1403 Printer

The IBM 1403 Printers used with IBM System/360 are fully buffered. Depending on the type of channel to which the printer is connected, it operates in burst mode (selector-channel or multiplexer-channel burst mode) or interleave burst of four bytes each in multiplex mode (multiplexer channel). A switch on the CE panel can be set so that, on the multiplexer channel, the buffer is loaded in burst mode.

The three low-order bits of the write command sent over the channel do not cause any automatic carriage operation. However, modifier bits accompanying the write command can accomplish spacing of one, two, or three lines, or skipping after printing.

For independent carriage-control operation, a control command must be transmitted to the control unit before the write command. Modifier bits (0 through 4) in this control command determine the extent of carriage motion. No additional byte of control information is required.

The control command is an immediate command; channel-end is the 2821 response to the channel when the command is accepted.

At completion of the carriage function, a device-end is sent to the channel. After the device-end, a write command should follow. Following the write command, the print buffer is loaded. The buffer is filled in either burst mode (the channel is tied up for the whole record), or in data-interleave mode (in which a new selection of the control unit occurs for each group of four bytes to be transferred from the channel to the print buffer).

Buffer loading is terminated by a stop (CCW data count decremented to zero) from the channel or by channel-end from the control unit (the buffer has been filled), depending upon which occurs first. The channel is freed and mechanical action of printing a line is started, followed by a carriage operation if the modifiers accompanying the write command were set up to cause it. At the mechanical end of the print cycle (including any carriage movement that follows printing) the control unit sends the status information of the printer along with device-end to the channel (device-end is sent at the beginning of carriage-settling time), thereby causing an interruption. After device-end has been accepted by the channel, a new operation of the printer can be initiated.

Note that the maximum record length for the 1403 Model 7 is the same (132 positions) as that for the 1403 Models 2, 3, and N1, even though the 1403 Model 7 has only 120 print positions. Hence, insofar as the CCW SLI (Suppress Length Indication) flag is concerned, programming for these printers is identical. Refer to IBM System/360 Principles of Operation, Form A22-6821, for a description of the SLI flag.

OPERATION COMMANDS

The valid commands for the IBM 1403 Printer are:

- Read (for diagnostic purposes)
- Write
- Control
- Sense

Modifier bits in conjunction with the write command can designate the following functions:

<u>Interface Bits</u>		<u>Function</u>
<u>Modifiers</u>	<u>Command</u>	
<u>01234</u>	<u>567</u>	
00000	001	Write (no automatic space)
00001	001	Write and space 1 line after printing
00010	001	Write and space 2 lines after printing
00011	001	Write and space 3 lines after printing
10001	001	Write and skip to channel 1 after printing
10010	001	Write and skip to channel 2 after printing
10011	001	Write and skip to channel 3 after printing
10100	001	Write and skip to channel 4 after printing
10101	001	Write and skip to channel 5 after printing
10110	001	Write and skip to channel 6 after printing
10111	001	Write and skip to channel 7 after printing
11000	001	Write and skip to channel 8 after printing
11001	001	Write and skip to channel 9 after printing
11010	001	Write and skip to channel 10 after printing
11011	001	Write and skip to channel 11 after printing
11100	001	Write and skip to channel 12 after printing
00000	100	Sense

Independent carriage operations are expressed by modified control commands as follows:

<u>Interface Bits</u>	<u>Function</u>
<u>01234567</u>	
00001011	Space 1 line immediately
00010011	Space 2 lines immediately
00011011	Space 3 lines immediately
10001011	Skip to channel 1 immediately
10010011	Skip to channel 2 immediately
10011011	Skip to channel 3 immediately
10100011	Skip to channel 4 immediately
10101011	Skip to channel 5 immediately
10110011	Skip to channel 6 immediately
10111011	Skip to channel 7 immediately
11000011	Skip to channel 8 immediately
11001011	Skip to channel 9 immediately
11010011	Skip to channel 10 immediately
11011011	Skip to channel 11 immediately
11100011	Skip to channel 12 immediately
00000011	No-op

If a skip-immediate command is given and the carriage tape is already at the channel specified, the command is accepted. However, whether or not carriage movement occurs depends upon the previous command.

Carriage movement for the skip-immediate command occurs only if a write (with no automatic spacing) or a UCS load (11111011 or 11110011) command is accepted between the last command that caused carriage operation and the skip-immediate command. Otherwise, carriage motion does not occur for the skip immediate command. (The 2821/1403 must have the Universal Character Set feature for the UCS load command to be valid.) However, when the carriage tape is already at the channel specified by a write and skip command, skipping does occur after the line is printed.

Test I/O

The Test I/O section in the 2540 portion of this manual applies equally to the printers.

No-Op

The no-op is an immediate command. When this command is accepted, the 2821 immediately returns device-end and channel-end status to the channel.

Sense

The sense command is not an immediate command. The initial data count in the sense command should be equal to one, because only one sense byte is returned to the channel. Device-end and channel-end are presented to the channel after completion of transfer of the sense byte to the channel.

STATUS BYTE

The bits of the status byte are set in the control unit. Unit-check conditions specified in the status byte may require that the sense-byte information be obtained from the control unit by an additional sense command.

Bit 0 – Attention (Not Used)

Bit 1 – Status Modifier

Bit 2 – Control Unit End

Bits 1 and 2 do not apply to printer operations. (However, see the Two-Channel Switch section for exceptions.)

Bit 3 – Busy

Busy status is given only at initial selection and indicates that the printer cannot execute the command because a previously initiated operation is being executed, or because an interruption condition exists. An operation is being executed from the time status at initial selection is accepted until device-end for the operation is accepted by the channel.

The interruption condition is caused by an outstanding channel-end, device-end, or any status being stacked by the channel to the 2821/1403.

If the printer is in the busy condition, no other status bits are presented to the channel unless the interruption condition is present.

Bit 4 – Channel End

This indicates the channel is free to disconnect from the control unit because data transfer, if any, over the interface has been completed. This bit is not set on by execution of a Test I/O or a command rejected during selection.

Bit 5 – Device-End

This indicates the printer has completed the previous command or has just become ready and is free to accept a new command.

Bit 6 – Unit-Check

This indicates that the printer or controls require program or operator intervention. The setting-on of any sense bit causes unit-check to be set on. See the sense bit descriptions for details.

Bit 7 – Unit Exception

A hole has been sensed in channel 12 of the carriage control tape. This bit appears with device-end and is set only on a carriage space operation (not on a carriage skip).

Note: With the following two exceptions, the preceding status-byte conditions are reset to zero when they are accepted by the channel.

1. If a unit-check was caused by an intervention-required condition, status bit 6 is reset only after the printer has been restored to the ready condition by a manual operation.
2. Busy is reset only after the channel has accepted device-end.

SENSE BYTE

Except for intervention required, all sense bits for the device are reset upon acceptance of any new command to the device (other than Sense, Test I/O, or No-op).

Bit 0 – Command Reject

1. Any command other than those defined for 1403 printers (in this publication) was received.
2. A command for an uninstalled feature was received.

Bit 1 – Intervention Required

This indicates that the printer has entered a not-ready condition because one of the following has occurred.

1. The stop key was operated.
2. A mechanical interlock is open.
3. A forms check has occurred due to:
 - a. A forms jam,
 - b. Carriage tape cover open or carriage tape missing,
 - c. The carriage stop key was operated, or
 - d. The carriage drive is not in the neutral or drive position.
4. A sync check has occurred. The type array is out of synchronism with the printer controls.
5. An end-of-forms condition has occurred.
6. A write command has been performed after the single-cycle key was operated.

Intervention required is reset only when the printer is made ready.

Bit 2 – Bus-Out Check

This indicates that a bus-out parity error has occurred:

1. On the command byte, or
2. On a data byte for a write, a selective tape listing control, or a UCS load control command.

If the error occurs on a data byte during a write command, printing is not suppressed. If the error occurs on the data byte for a selective tape listing control command, the tape-spacing magnets are not set up for the spacing specified by the bad-parity byte. If the error occurs on a data byte for a UCS load command, buffer loading continues.

A unit-check due to a bus-out check for a data byte is given with channel end.

Bit 3 – Equipment Check

This indicates a program-resettable malfunction was detected in the printer or its controls. This error indication is reset by acceptance of the next write or control command. The checks are:

1. Hammer check, or
2. Buffer parity check.

Bit 4 – Data Check

This indicates that an invalid card code was detected for a 1404 with the read compare feature. It also

indicates that an uncomparable data code was sent to a 1403/2821 using the Universal Character Set feature.

Bit 5 – UCS Parity

This bit indicates that a code generator (240-character storage) parity error occurred when using the Universal Character Set feature.

Bit 6 – Unusual Command Sequence

This indicates that a read command has followed a read command with no intervening card feed for a 1404 in card mode.

Bit 7 – Channel 9

This indicates that the carriage brushes sensed channel 9 during the previous carriage space (evidenced by unit-check in the status byte). This bit is not set during a carriage-skip operation.

POSSIBLE COMBINATIONS OF STATUS BITS IN A STATUS BYTE (FOR 1403 AND 1404)

Bit positions of the status combinations presented are in the order: 01234567.

Note that these are status combinations presented to the channel from the 2821. For further information as to how status is placed in the CSW (Channel Status Word), refer to IBM System/360 Principles of Operation, Form A22-6821. There should never be a combination that includes a 1 in bit positions 0, 1, or 2. Combinations that should not occur, do occur only as a result of a machine malfunction.

In the following descriptions: An asterisk (*) indicates that the combination is given only at initial selection for a test I/O command or when status is presented in a sequence initiated by the 2821. A double asterisk (**) indicates that the combination is given only at initial selection for a command other than a Test I/O.

1. 0 0 0 0 0 0 0 0

A response at initial selection when a read, write, UCS load, STL control, or sense command is accepted. Also, a response to a Test I/O command when the device is ready and not busy.

2. 0 0 0 0 0 1 0 0

*● Given when a write or control command (other than a No-op, UCS load, or STL command) is completed.

*● Or, given when the device has gone from the not-ready to the ready state.

3. 0 0 0 0 0 0 1 0

● Given at initial selection when a command is not accepted because one or more of the following sense bits is on as a result of the indicated condition (see appropriate sense bit description):

<u>Bit</u>	<u>Condition May Occur for</u>
0	any command
1	any command other than sense
2	any command

*● Or, given if status was stacked by the channel during initial selection.

4. 0 0 0 0 0 0 0 1

Should not occur.

5. 0 0 0 0 0 1 1 0

*● Given when a write or control command (other than a No-op, UCS gate, UCS block data check, UCS reset block data check, or STL command) is completed and one or more of the following sense bits is on as a result of the indicated condition:

<u>Bit</u>	<u>Condition May Occur for</u>
3	Any write command, or a 1404 in card mode (with the read-compare feature) after a feed and write, or control command is given.
4	Any write command, if the unit is equipped with the Universal Character Set feature.
5	Any write, or a UCS load command, if the unit is equipped with the UCS feature.
6	A 1404 in card mode (with the read-compare feature) after a command that causes a card feed is given.
7	Any command causing a carriage space.

*● Or, given because the device goes from the not-ready to the ready state (creating device-end status) and then back to the not-ready state (before device-end is accepted).

*● Or, given because a unit-check status (due to sense bit 0 or 2) is stacked by the channel and the device goes from the not-ready to the ready state before the unit-check is accepted.

6. 0 0 0 0 0 1 0 1

* Given because a write or control command that causes a carriage space is completed and a hole is sensed in channel 12 of the carriage tape.

7. 0 0 0 0 0 1 1 1

* Given because a write or control command that causes a carriage space is completed, and a hole is sensed in channel 12 of the carriage tape, and one or more of the following sense bits is on as a result of the indicated condition:

<u>Bit</u>	<u>Condition May Occur for</u>
3	Any write command, or a 1404 in card mode (with the read-compare feature) after a feed and write command with a carriage space is given.
4 or 5	Any write command (if the unit is equipped with the UCS feature).
6	A 1404 in card mode (with the read-compare feature) when a feed and write with a carriage space is given.
7	A 9-hole was sensed in the carriage tape during a command that caused a carriage space operation.

8. 0 0 0 0 0 0 1 1

Should not occur.

9. 0 0 0 1 1 0 0 0

** Given when data transfer (if any) is completed for a previous write or control command (other than a No-op, UCS gate, UCS block data check, UCS reset block data check, or STL command) but channel-end status is not yet accepted by the channel.

10. 0 0 0 1 1 1 0 0

** Given when a previous command is completed, but channel-end and device-end status is not yet accepted by the channel.

11. 0 0 0 1 1 0 1 0

** Given when data transfer (if any) is completed for a previous write or control command (other than a No-op, UCS gate, UCS block data check, UCS reset block data check, or STL command) but channel-end status is not yet accepted by the channel and one or more of the following sense bits is on as a result of the indicated condition:

<u>Bit</u>	<u>Condition May Occur for</u>
2	Any write or UCS load command.
3	Any write command.
4	Any write command (if the unit has the UCS feature).
5	Any write or UCS load command (if the unit has the UCS feature).
6	A 1404 in card mode (with the read compare feature) after a command that causes card feeding is given.
7	A 9-hole was sensed in the carriage tape during a command that caused a carriage-space operation.

12. 0 0 0 1 1 0 0 1

Should not occur.

13. 0 0 0 1 1 1 1 0

** Given when a previous read, write, or control command (other than a No-op, UCS gate, UCS block data check, or UCS reset block data check command) is completed, but channel-end and device-end status is not yet accepted by the channel and one or more of

the following sense bits is on as a result of the indicated condition:

<u>Bit</u>	<u>Condition May Occur for</u>
2	Any write command, an STL control command, or a UCS load command.
3	Any read command, any write command, or a UCS load command; or a 1404 in card mode (with the read-compare feature) and a feed and write or control command is given.
4	Any write command if the unit has the UCS feature, or a 1404 in card mode (with the read compare feature) after a read command is given.
5	Any write command or UCS load command (if the unit has the UCS feature).
6	A 1404 in card mode (with the read compare feature) after a command that causes a card feed, or a read command is given.
7	Any command causing a carriage space in which the carriage 9-hole is sensed.

14. 0 0 0 1 1 1 0 1

** Given when a previous write or control command that causes a carriage space is completed, and a hole is sensed in channel 12 of the carriage tape, but channel-end and device-end status is not yet accepted by the channel.

15. 0 0 0 1 1 1 1 1

** Given for the same conditions listed under 14, except that one or more of the following sense bits is on as a result of the indicated condition:

<u>Bit</u>	<u>Condition May Occur for</u>
2	Any write command.
3	Any write command or a 1404 in card mode (with the read-compare feature) after a feed and write command with a carriage space is given.
4 or 5	Any write command if the unit is equipped with the UCS feature.
6	A 1404 in card mode (with the read-compare feature) after a feed and write command with a carriage space is given.
7	A 9-hole was sensed in the carriage tape during a command that caused a carriage space.

16. 0 0 0 1 1 0 1 1

Should not occur.

17. 0 0 0 0 1 0 0 0

● Given at initial selection of a control command (other than a No-op, UCS gate, UCS block data check, UCS reset block data check, or STL command).

*● Or, given when data transfer is completed for a write or UCS load command.

*● Or, given if this same status at initial selection for a control command (other than a No-op, UCS gate, UCS block data check, UCS reset block data check, or STL command) is stacked by the channel.

18. 0 0 0 0 1 1 0 0

● Given at initial selection of a No-op, UCS gate, UCS block data check, or UCS reset block data check when the command is accepted.

*● Or, given when a previous command is completed, but channel-end and device-end are not yet accepted by the channel.

*● Or, given if this same status at initial selection of a No-op, UCS gate, UCS block data check, or UCS reset block data check command is stacked by the channel.

19. 0 0 0 0 1 0 1 0

* The same as status combination 11.

20. 0 0 0 0 1 0 0 1

Should not occur.

21. 0 0 0 0 1 1 1 0

* Given when a read, write, or control command (other than a No-op, UCS gate, UCS block data check, or UCS reset block data check command) is completed

and one or more of the following sense bits is on as a result of the indicated condition:

<u>Bit</u>	<u>Condition May Occur for</u>
2	Any write command, an STL control command, or a UCS load command.
3	Any read command, any write command or a UCS load command; <u>or</u> a 1404 in card mode (with the read-compare feature) after a feed and write or control command is given.
4	Any write command if the unit has the UCS feature, or a 1404 in card mode (with the read-compare feature) after a read command is given.
5	Any write or UCS load command if the unit has the UCS feature.
6	A 1404 in card mode (with the read-compare feature) after a command that causes card feeding, or a read command is given.
7	Any command causing a carriage space and a carriage 9-hole is sensed during the space operation.

22. 0 0 0 0 1 1 0 1

* A write or control command that causes a carriage space is completed and a hole is sensed in channel 12 of the carriage tape.

23. 0 0 0 0 1 1 1 1

* Given because of the same condition that causes combination 22. However, one or more of the following sense bits is on:

<u>Bit</u>	<u>Condition May Occur for</u>
2	Any write command.
3	Any write command, <u>or</u> a 1404 in card mode with the read-compare feature) after a feed and write command with a carriage space is given.
4 or 5	Any write command if the unit has the UCS feature.
6	A 1404 in card mode (with the read-compare feature) after a feed and write (with carriage space) command is given.
7	A 9-hole was sensed in the carriage tape during a command that caused a carriage space.

24. 0 0 0 0 1 0 1 1

Should not occur.

25. 0 0 0 1 0 0 0 0

Normal response given to any command issued to the device when that device is between channel-end and device-end.

26. 0 0 0 1 0 1 0 0

**● Given when a write or control command (other than a No-op, UCS gate, UCS block data check, UCS reset block data check, or STL command) is completed, but device-end status is not yet accepted by the channel.

**● Or, given because the device goes from the not-ready to the ready state, but device-end status is not yet accepted by the channel.

27. 0 0 0 1 0 0 1 0

** Given because status combination 3 was stacked by the channel.

28. 0 0 0 1 0 0 0 1

Should not occur.

29. 0 0 0 1 0 1 1 0

** Given because status combination 5 is not yet accepted by the channel.

30. 0 0 0 1 0 1 0 1

** Given because status combination 6 is not yet accepted by the channel.

31. 0 0 0 1 0 1 1 1

** Given because status combination 7 is not yet accepted by the channel.

32. 0 0 0 1 0 0 1 1

Should not occur.

POSSIBLE COMBINATIONS OF SENSE BITS IN A SENSE BYTE

Assume that the previous command has been executed and that unit-check status has been given with channel-end or device-end.

Previous Command

Sense Bits

*Write

Any one or more of the following:

- B1 - Intervention required
- B2 - Bus-out check
- B3 - Equipment check
- B4 - Uncomparable data code (UCS)
- B5 - UCS parity
- B6 - Unusual command sequence (1404)
- B7 - Channel-9 (if the write command specified a carriage-space operation).

*Control

Any one or more of the following:

- B1 - Intervention required
- B2 - Bus-out check (for UCS load or STL)
- B3 - Equipment check (UCS load or 1404)
- B5 - UCS Parity
- B6 - Unusual command sequence (1404)
- B7 - Channel-9 (for a non-STL control command that specified a carriage-space operation).

Read

Any one or more of the following:

- B1 - Intervention required
- B3 - Equipment check
- B4 - Data check (1404)
- B5 - UCS parity (can occur only if the command was a diagnostic read)
- B6 - Unusual command sequence (1404).

*Either UCS load command (i.e., with or without folding) can be considered both a write and a control command.

DIAGNOSTIC COMMANDS FOR THE 1403 CONTROLS

These commands are described here, but they are intended only for Field Engineering use in diagnostic tests.

Diagnostic Write (-----101)

The diagnostic write command is executed the same as a normal write during data transfer. At the completion of the data transfer, only one print scan consisting of 3 subscans takes place. No printing or carriage movement takes place. Various data configurations can be entered to check the print translator and buffer. A chain configuration can be loaded to check the print character generator. If the print character generator is operating correctly, all positions of the print-line-complete check plane contain a bit. Bits 0 through 4 of the command byte must have a valid combination for normal printing.

Diagnostic Data Read (00000010)

The Diagnostic Data Read performs data transfer from the buffer to the channel. This command normally follows a diagnostic write. The data returned is compared with the data written. The relationship between buffer bits and the data byte is as follows for a unit not equipped with the Universal Character Set feature.

<u>Buffer</u>	<u>Byte Bit Position</u>
C	1
B	2
A	3
8	4
4	5
2	6
1	7

If the Universal Character Set feature is present, the data returned is identical to that transmitted on the write command. Analysis of the data returned determines whether the translator and buffer controls are operating and localizing problems correctly in case of errors. The data transfer on a diagnostic read is in two-byte bursts when in multiplex mode.

Diagnostic Check Read (00000110)

This command transfers check information to the channel. The data transmitted is as follows:

Bit Position of Check Read

- 5 print line complete
- 6 print check plane
- 7 parity check.

The print-line-complete plane is used to determine if the print character generator is working properly. The print check and parity check are used to locate the position of error without having to go off-line. Data transfer is in two-byte bursts when in multiplex mode.

USE METER

A printer use-meter starts running after the printer is ready and has become busy executing a write command. The use-meter then continues to run while the 2821 meter is running, and the 1403 is on-line. The 1403 use-meter stops if the carriage space or restore key is operated.

PRINTER KEYS AND INDICATORS

Print-Start Key

This key puts the printer in the ready condition and initiates a device-end. A duplicate start key is located at the rear of the printer for operator convenience.

Check-Reset Key

This key is used to reset a printer error indication. Press the start key to resume operation.

Print-Stop Key

This key places the printer in a not-ready condition at completion of the instruction in progress. A duplicate stop key is provided at the rear of the machine for operator convenience.

End-of-Forms Light

When an end-of-forms condition occurs, unit-check (status bit 6) is sent to the channel at the next initial selection. Subsequently, intervention required (sense bit 1) is sent during a sense operation. Also, the printer ready light turns off and the printer end-of-forms light turns on when the end-of-forms condition occurs.

To reset the printer, the operator must press the printer start key. The remaining lines of the form are then printed under program control. (The operator does not press the start key for each remaining line to be printed. He presses the start key only once.) Alternately, the single-cycle key can be used. In this case, one line of print occurs for each operation of the single-cycle key.

When a hole is sensed in channel-1 (either space or skip to or by channel-1) of the carriage tape, the operation is terminated with both the end-of-forms and the forms-check lights on. Therefore, you must provide a carriage tape with a hole in channel-1 for proper ending of the printing operation. If there is no hole in channel 1, printing continues even though there are no forms in the printer. Printing does not occur for the line after the channel-1 hole is sensed.

If a skip to a channel other than channel-1 is specified, that skip is completed even though forms-check is set when channel-1 is sensed.

Forms-Check Light

This light indicates paper-feed trouble (see Sense Byte) or indicates that the carriage stop key has been operated. This light must be turned off by the check-reset key before the print-start key is effective.

Ready Light

This light turns on when the printer is in ready condition.

Print Check Light

This light indicates a print hammer check or a print parity check. In the case of the Universal Character Set feature, this light is turned on by detection of a parity check in the 240-character storage. It is turned off when the next valid command to the printer (other than Sense, Test I/O, or No-op) is accepted.

Sync Check Light

This light turns on to show that the type was not synchronized at all times with the compare counter for the printer. The light is turned off by pressing the check-reset key.

Single-Cycle Key

Pressing the single-cycle key makes the printer ready (ready light turns on) if none of the following conditions exist:

1. The sync-check light is on.
2. The forms-check light is on.
3. A mechanical interlock is open in the printer (e.g., T-casting is open).
4. Either the front or rear stop key is held operated.

The printer then remains ready until a write command is executed. At initial selection for the next command (after the single write command is executed), unit-check status (bit 6) is presented to the channel because sense bit 1 (intervention required) is on. If another single-cycle operation is desired, press the single-cycle key again. If, however, the operator does not want further single-cycle operations, he presses the start key to return to normal continuous operation.

Note that for single-cycle operation, the printer goes not-ready only after a write command is executed. Therefore, if the single-cycle key is pressed, commands (such as a control command to skip) are processed until a write command is executed. Then the printer goes not-ready.

Also, if a command is being executed when the single-cycle key is pressed, the printer may go not-ready at the completion of the command in process, or after the next write command.

Power-On Light (1403-N1 Only)

This light indicates that power is on in the 1403-N1.

Carriage Keys

Restore Key

Pressing this key positions the carriage at channel 1 (home position). If the carriage feed clutch is disengaged, the form does not move. If it is engaged, the

form moves in synchronism with the control tape. Pressing this key when the ready light is on causes no carriage motion. However, when this key is released, the use meter is stopped until the next write command is accepted.

Carriage Stop Key

Pressing this key stops the carriage operation and turns on the forms-check light.

Space Key

Each time this key is pressed, the forms advance one space. Pressing this key when the ready light is on causes no carriage motion. However, when this key is released, the use meter is stopped until the next write command is accepted.

Cover Raise and Cover Lower

These two switches are provided on the 1403-N1 to activate the motor that raises and lowers the upper cover of the printer. These switches are located at both the front and rear of the 1403-N1 for operator convenience.

SPECIAL FEATURES

Interchangeable Chain Cartridge Adapter (1403-2 and 1403-7 Only)

This feature permits the operator to insert an interchangeable chain cartridge with a different type font, or special-character arrangement. After installation, the change of cartridges can be made quickly by the operator without using special tools. Printer operation is not affected.

This interchangeable capability is standard on all IBM 1403 Model 3 Printers and IBM 1403-N1 Printers. However, the train cartridges used on Models 3 and N1 cannot be used on Models 2 and 7, and the chain cartridges used on Models 2 and 7 cannot be used on Models 3 and N1.

Selective Tape Listing Feature (1403-2, -3, and -N1 Only)

This feature permits mounting from one to eight paper tapes on which separate printing can be done.

Tapes of two widths can be used: 1.5 inch or 3.1 inch. Eight of the 1.5-inch widths are maximum, and each 3.1-inch tape replaces two of the 1.5-inch tapes. The tapes can be advanced independently, or different combinations can be advanced concurrently. This movement can be only one space at a time and only after printing.

When the feature is mounted and moved to the correct operating position (the left side of the carriage), normal control of printing from the channel by CCW is replaced as shown in the following description.

To begin a selective tape listing operation, any valid space or skip control command (for a 1403 printer) is sent to the 2821 by the channel. For example, the space one line immediately control command (bit structure: 00001011) can be sent. The control command conditions circuitry in the 2821 for the next step in the operation. Note that any modifier bits in the control command are ignored.

The next step in the operation is to send a control byte to the 2821. This control byte can be sent in the same manner as any data byte. The byte in main storage is addressed by the skip or space control command. The count field in the control command is set to one. (In non-selective tape listing operations, the data address of the space or skip CCW is ignored.) The control byte indicates which tapes are to be spaced after the write operation. Each bit of the control byte indicates each paper tape of the possible eight tapes.

Therefore, think of the carriage as having eight possible tape positions corresponding to where the eight 1.5-inch tapes would be located. If a bit in the control byte is a 1, spacing of one line after the next print occurs for the corresponding tape. If two or more bits are set to 1, each of the corresponding tapes moves (simultaneously) one space after the next print.

The bit assignment is such that the low-order bit (bit 7) refers to the leftmost tape. The other ascending bits correspond to the tape positions ranging from left to right.

Any 3.1-inch tape must be spaced by setting the corresponding bits referring to the two 1.5-inch tape positions it covers. Otherwise, unpredictable spacing occurs. Thus, if four tapes are mounted, each being of the double width, the control bytes must contain 1-bits in the four proper pairs.

A write command is then sent to cause printing to occur. The write command can be any one of the valid 1403 write commands. All spacing occurs after printing.

Selective Tape Listing Feature (1403 Model N1 on System/360 Models 25, 30, 40, and 50 Only)

2821 Feature Code 6425

1403 N1 Feature Code 6420

This feature allows, under program control, both skipping and spacing of tapes on the 1403 Model N1 only. (The feature cannot be used on any other model of the 1403.) Manually controlled tape skipping, primarily provided to facilitate tape removals and to move tapes into viewing position, can be done by use of keys on the printer.

A stacker is permanently attached to the top cover of the 1403 Model N1. The operator can load new tapes, and by using the top stacker, remove processed stacked tapes without leaving the front of the printer. For operator procedures, see the IBM 1403 Printer Component Description, Form A24-3073.

Tapes can be printed when all covers of the printer are closed. Because the 1403 Model N1 has acoustical covers, operation with the covers closed greatly reduces the sound level produced by high-speed printing.

From one to eight 1.5-inch (single-width) paper tapes (usually detail tapes) can be mounted and printed. The 3.1-inch tapes (usually master tapes) can also be used. Each double-width tape replaces two single-width tapes. Only single-part fanfold tapes can be used, regardless of the width of the tape.

Double-width tapes can be mounted in the following single-width positions only:

1-2
3-4
5-6
7-8

Numbering of tapes is from left to right, with single-width tape 1 located at the leftmost tape position of the print line.

A maximum of 13 characters can be printed on a single-width tape. Single blank-character positions at each edge of a tape are used for margins. A maximum of 29 characters can be printed on a double-width tape: two 13-character groups, two margin positions used on the two single-width tapes, and the position not used between the two single-width tapes.

When the Selective Tape Listing feature is operated on the 1403 Model N1, printing speed (at 6 lines per inch only) is at a maximum rate of:

1. 1400 lines per minute if the Universal Character Set feature is installed in the 2821 and 1403 N1.
2. 1100 lines per minute if the Universal Character Set feature is not installed.

Any combination of tapes can be printed and line-spaced or skipped. Skipping in selective tape list mode is accomplished at 33 inches per second only. The length of the desired skip must be predetermined for the applications. A customer engineer adjusts the printer so that all tape skips are done at the same specified distance. The range of adjustment is from 3 to 22 inches. Skipping is then done only at the one specified value.

Program control of skipping and spacing is set up through use of the normal space- or skip-immediate control commands. When used with selective tape listing operations, these commands must address one byte of control information that has previously been placed in main storage. (Note that the data-address portion of a space or skip CCW is ignored when the printer is not in selective tape list mode.) The byte of information determines which tapes are to be spaced or skipped after the next write-and-space or write-and-skip command. Spacing or skipping occurs only if the control command precedes a write-and-space or write-and-skip command. Spacing or skipping does not occur if a write-with-no-space command follows the control command. The control byte in the 2821 is reset to zeros after tape movement occurs for any write command or after a write-with-no-space command.

Each bit (when on) in the data byte controls spacing or skipping of a particular tape, as follows:

Data byte bit	7	6	5	4	3	2	1	0
Tape position	1	2	3	4	5	6	7	8
								▲ (leftmost tape)

If a double-width tape is to be skipped or spaced, two bits in the data byte must be on to ensure proper spacing or skipping for that tape. For example, suppose that the leftmost tape is a double-width tape. (It occupies single-width tape positions 1 and 2.) Then bits 6 and 7 must be on in the data byte to control movement of that tape. If both bits are not on (a programming error) for a double-width tape, the distance the tape moves may not be the desired distance, or a failure to space may be signaled.

Any skipping after printing is always at the specified length set into the printer by the customer engineer.

Multiple space or skip control commands, without an intervening write command, continue to condition tapes for spacing or skipping after the next write-and-space or write-and-skip command. For example, in the following sequence, tapes 1, 2, and 8 are moved after the write-and-space command:

1. Control command to condition spacing of tapes 1 and 8.
2. Control command to condition spacing of tapes 2 and 8.
3. Write-and-space command.

Note that the write command (and not the skip- or space-immediate control command) determines whether skipping or spacing is to occur. For example, if a space-immediate control command precedes a write-and-skip command, the specified tapes are skipped. They are not spaced.

An out-of-tape condition causes the end-of-forms and forms-check lights to turn on, and the top cover of the printer to rise automatically to provide access to the tapes. A failure-to-space or a broken-tape condition causes only the forms-check light to turn on. The top cover of the printer does not rise automatically on a broken-tape or a failure-to-space condition.

A failure to space may not be detected until after the next line is printed. Therefore, the line that follows after spacing did not occur may be overprinted once.

A blank carriage tape should be placed in the carriage for STL operations. A forms check occurs if no tape is installed. Channel-9 and -12 punches are detected if the carriage tape is so punched.

Auxiliary Ribbon Device Feature

This feature makes it possible to use polyester ribbons so that characters printed can be read by the IBM 1418 Optical Character Reader, the IBM 1428 Alphameric Optical Character Reader, and the IBM 1282 Optical Reader Card Punch. This feature is standard on the 1403-3 and 1403-N1 printers.

.079-Inch High Type

The .079-inch high font is available for all printers described in this publication. This type has slightly shorter letters than the .095-inch type, thereby allowing the user a choice of type size. The .079-inch

and .095-inch type styles should not be intermixed on a chain or train, because the base lines of the two style type slugs are not the same. That is, wavy printing will be produced.

Universal Character Set Special Feature (1403-2, -3, and -N1 Only)

Description

The Universal Character Set feature provides for printing any set of graphics (240 maximum) by the 1403 printers attached to the 2821 Control Unit in IBM System/360. The graphics can be arranged in any desired sequence on the print chain (1403-2) or print train (1403-3 and 1403-N1).

The Universal Character Set feature offers the following advantages:

1. Chain/train arrangements are provided in addition to the AN, HN, PCS-AN (Preferred Character Set- AN), PCS-HN (Preferred Character Set-HN) and QNC available for System/360 (Figures 12 and 13). The UCS arrangements are for use and optimization of applications requiring:
 - High-speed alphameric capability
 - Programming Language/I (PL/I)
 - Commercial applications of FORTRAN and COBOL
 - Both commercial and scientific text printing.
2. Any previously announced chain or train configurations for IBM 1400-series systems are available for use with the Universal Character Set feature.
3. Chains or trains can be designed by the customer, tailored to his own needs, using the guidelines and within the limitations defined in this publication. Chains can be used only on 1403-2, and trains only on 1403-3 and 1403-N1 printers.

Note: Intermixes of type styles, other than 1428 and .095-high, which are compatible, can produce wavy printing because the type-style base lines are not the same.

Method of Operation

The Universal Character Set feature utilizes a 240-character read/write storage unit in the IBM 2821

Control Unit. Each position in the 240-character storage corresponds sequentially to each graphic on the installed print train or chain. This 240-character storage is read out in printing-position sequence as the various graphics are brought into printing position by the movement of the train or chain. Bit patterns read out of the 240-character storage are matched to the successive bit patterns of the data record to be printed. Note that the data record is moved to the printer, in the normal manner, by a write command. When a bit pattern read out of the 240-character storage matches a bit pattern from the data record, the corresponding print position prints.

The bit patterns in the data record correspond to those selected from the 256 bit patterns of the 8-bit processing unit byte. They must also correspond to the bit patterns contained in the 240-character storage unit (each location of which contains 8 information bits plus a parity bit). If a bit pattern in the data record (except null, 0000 0000, and blank, 0100 0000) does not match any of the bit patterns in the 240-character storage, nothing is printed in the print position to which the unmatching data-record bit pattern applies. In this case, printing for the line is stopped after the chain or train has reached its home position twice. A device-end with a unit-check then results, and bit 4 of the sense byte is turned on. This condition is called a data check. Note, however, that unit-check is not set if the block-data-check condition is in force (due to previous execution of a block-data-check command; see the Data Check Control section).

The null (0000 0000) and blank (0100 0000) bit patterns are used to provide for blank spaces in the printed line. Hence, each position of the data record that contains a null or blank bit pattern results in a space in the associated position of the print line.

Null and blank are the only bit patterns that do not cause a data check when they do not compare to a bit pattern stored in the 240-character storage. Either of these codes can be loaded in the 240-character storage. If they are loaded, and then a null or blank bit pattern is sent to the 2821 in a print record, printing and data checks do not occur for these bit patterns. If folding is in effect, the bit patterns 1000 0000, 1100 0000, 0000 0000, and 0100 0000 all operate in the manner just described for bit patterns 0000 0000 and 0100 0000. (See the Changing Bit Patterns in the 240-Character Storage section for information about folding.)

Bit patterns, other than those loaded in the 240-character storage, and other than null and blank (or

the bit patterns 0000 0000, 1000 0000, 1100 0000, and 0100 0000 if folding is in effect), are called UCS undefined-graphic bit patterns.

If a standard 48-character train or chain (A through K, AN, or HN) is used, the bit pattern representation in the 240-character storage for each of the five sets of 48 graphics must be the same. If two or more different bit patterns are used for the same graphic, data checks may occur.

For example, the normal code for the character "1" is 1111 0001. Suppose that an arbitrary, alternate bit pattern of 0111 0001 is also assigned (incorrectly) to the "1" in a 48 AN train. Assume that these bit patterns are then loaded alternately into positions of the 240-character storage that correspond to the positions of the "1's" on the train. The storage positions loaded would be:

<u>240-Character Storage Position</u>	<u>Bit Pattern</u>
1	1111 0001 (correct)
49	0111 0001 (incorrect)
97	1111 0001 (correct)
145	0111 0001 (incorrect)
193	1111 0001 (correct)

Now, assume that a data record containing the incorrect bit pattern (0111 0001) for the "1" graphic is sent to the printer. Two entire character sets might pass the print position during the time the incorrect bit pattern for the "1" is being compared to the contents of the 240-character storage. These two sets could be the ones represented by 240-character storage positions 193 through 240 and 1 through 48. Here, two 48-character sets pass the print position without a match of the 0111 0001 bit pattern with any bit pattern in the 240-character storage. In this case, what is known as home position is passed twice. The machine senses the difference in home positions of a train between 48 AN or HN and any UCS chain. A tab on the cartridge actuates a switch on a Model 3 or N1. Other models have a jumper in the UCS transducer. If home position is passed twice without a correct bit pattern comparison, a data check occurs.

If it is necessary to use two different bit patterns for any graphic (other than those automatically dualled in the standard sets):

1. Replace an existing unused graphic in each of the five 48-character presentations (in the A through K, AN, or HN chain or train), or
2. Use the PCS-AN or PCS-HN arrangements.

● Figure 12. Chain Arrangements for System/360, Printout Representation (Part 2 of 2)

ODA - FIRST ARRAY

Note III

1	2	3	4	5	6	7	8	9	0	#	@	/	S	T	U	V	W	X	Y	Z	&	,	%	J	K	L	M	N	O	P	Q	R	-	\$	*	A	B	C	D	E	F	G	H	I	+	.	□
---	---	---	---	---	---	---	---	---	---	---	---	---	---	---	---	---	---	---	---	---	---	---	---	---	---	---	---	---	---	---	---	---	---	----	---	---	---	---	---	---	---	---	---	---	---	---	---

ONA - FIRST ARRAY

Note III

1	2	3	4	5	6	7	8	9	0	#	@	/	S	T	U	V	W	X	Y	Z	&	,	†	J	K	L	M	N	O	P	Q	R	-	\$	*	A	B	C	D	E	F	G	H	I	Y	.	¶
---	---	---	---	---	---	---	---	---	---	---	---	---	---	---	---	---	---	---	---	---	---	---	---	---	---	---	---	---	---	---	---	---	---	----	---	---	---	---	---	---	---	---	---	---	---	---	---

OAA - FIRST ARRAY

Note III

1	2	3	4	5	6	7	8	9	0	#	@	/	S	T	U	V	W	X	Y	Z	&	,	%	J	K	L	M	N	O	P	Q	R	-	\$	*	A	B	C	D	E	F	G	H	I	+	.	<
---	---	---	---	---	---	---	---	---	---	---	---	---	---	---	---	---	---	---	---	---	---	---	---	---	---	---	---	---	---	---	---	---	---	----	---	---	---	---	---	---	---	---	---	---	---	---	---

ONB - FIRST ARRAY (WTC Only)

Note III

1	2	3	4	5	6	7	8	9	0	=	'	/	S	T	U	V	W	X	Y	Z	&	,	>	J	K	L	M	N	O	P	Q	R	-	\$	*	A	B	C	D	E	F	G	H	I	+	.	<
---	---	---	---	---	---	---	---	---	---	---	---	---	---	---	---	---	---	---	---	---	---	---	---	---	---	---	---	---	---	---	---	---	---	----	---	---	---	---	---	---	---	---	---	---	---	---	---

Note III Five full sets per cartridge arrangement

Dualing of Graphics/Bit Patterns with the Universal Character Set Feature

The four graphics

% □ # @

of the AN arrangement are dualled with

() = ' ,

of the HN arrangement. This is accomplished by assigning the 48AN bit patterns from the EBCD Interchange Code (see Figure 11) to both the AN and HN configurations.

Dual mode indicates that a chain or train consisting of five identical sets of 48 characters is installed on the 1403. To attain the dualing capability for the 1400 series arrangements (A through K) as used with the Universal Character Set feature, the following rules apply:

1. For systems operating with the 1401, 1440, 1460 compatibility feature, assign the bit patterns of the AN arrangement to the load buffer for all arrangements.
2. For systems operating without the 1401, 1440, 1460 compatibility feature, assign the bit patterns of the EBCD Interchange Code (Figure 14) for each discrete graphic.

Note: For a description of dualing in a 1403 that does not have the Universal Character Set feature, refer to the Code Consideration and Dualing section of this publication.

Changing Bit Patterns in the 240-Character Storage

The contents of the 240-character storage are changed through use of either one of two special control commands. Previous contents of the 240-character storage are erased when new bit patterns are loaded. After the desired bit patterns are loaded, they remain unchanged until rewritten by the user.

To load the desired bit patterns and check the contents of the 240-character storage after loading, the user enters the coded punched-card information into CPU main storage. The procedure is:

1. The new data is punched in cards and loaded into main storage through a card reader.
2. The new loaded bit patterns are then transferred to the 240-character storage in the 2821.
3. The printer prints out the contents of the 240-character storage so that the loading operation can be checked.

IBM provides a utility program to implement this procedure (see the Universal Character Set Utility Program section).

The punched card hole patterns corresponding to the 256 bit patterns of the processing unit 8-bit byte are shown in Figure 14. Note in Figure 14 that the crosshatched areas (such as that shown for position 1010 1111) designate recommended bit patterns to be used for the 32 graphics (of the 120-character set) that are in addition to the 88 graphics shown for the EBCD Interchange Code.

Once the desired 240 bit patterns are in main storage, they are moved to the 240-character storage in the 2821 by either one of the following commands (CCW operation codes):

<u>Bit position</u>	<u>0123 4567</u>
UCS load (no folding)	1111 1011
UCS load (folding)	1111 0011

Either of these CCW's addresses the 240-byte main storage record loaded from the coded cards. For these operations, the Start I/O instruction contains the address of the printer used with the installed Universal Character Set feature. Immediately before either the no-folding or folding command is issued, a UCS gate command (operation code: 1110 1011) should be sent to the 2821. If this command does not precede the folding or no-folding command, then these commands are treated as invalid commands. The UCS gate must be the first command of a chain; if in any other position in a chain, it is rejected. This command conditions the 2821 to accept the command (folding or no folding) to load the 240-character storage. Hence, if the folding or no folding command is inadvertently sent to the 2821 without being preceded by the UCS gate, the contents of the 240-character storage cannot be destroyed. If the UCS gate command is reissued when the 2821 is already conditioned to accept UCS load commands, the command is accepted and the conditioning is left unchanged. The conditioning is reset when:

1. A command to load the 240-character storage is accepted, or
2. A write, skip, or space command is accepted, or
3. Power to the 2821 is turned off.

The conditioning is not reset by:

1. Chaining, or
2. Sense, Test I/O, No-op, block-data-check, or reset-block-data-check commands.

Bit Positions 4, 5, 6, 7 Second Hexadecimal Digit Digit Punctures		00				01				10				11				Bit Positions 0,1	
		00	01	10	11	00	01	10	11	00	01	10	11	00	01	10	11	Bit Positions 2,3	
		First Hexadecimal Digit																	
0	1	2	3	4	5	6	7	8	9	A	B	C	D	E	F				
9	9	9	9	9	9	9	9												
12				12	12		12	12	12		12	12							
	11				11	11	11		11	11	11		11						
		0			0		0	0	0		0	0			0				
0000	0	8-1	① NUL	② DLE	③ DS	④	⑤ SP	⑥ &	⑦	⑧			⑨	⑩	⑪	⑫	8-1		
0001	1	1	SOH	DC1	SOS				⑬		a	j		A	J	⑭	1	1	
0010	2	2	STX	DC2	FS	SYN					b	k	s	B	K	S	2	2	
0011	3	3	ETX	TM							c	l	t	C	L	T	3	3	
0100	4	4	PF	RES	BYP	PN					d	m	u	D	M	U	4	4	
0101	5	5	HT	NL	LF	RS					e	n	v	E	N	V	5	5	
0110	6	6	LC	BS	EOB	UC					f	o	w	F	O	W	6	6	
0111	7	7	DEL	IL	PRE	EOT					g	p	x	G	P	X	7	7	
1000	8	8		CAN							h	q	y	H	Q	Y	8	8	
1001	9	8-1		EM							i	r	z	I	R	Z	9	9	
1010	A	8-2	SMM	CC	SM		⋈	⋉	⑮	:								8-2	
1011	B	8-3	VT	CUI	CU2	CU3	.	\$,	#								8-3	
1100	C	8-4	FF	IFS		DC4	⑯	*	%	@				⋊		⋋		8-4	
1101	D	8-5	CR	IGS	ENQ	NAK	()	_	'								8-5	
1110	E	8-6	SO	IRS	ACK		+	;	>	=				⋍				8-6	
1111	F	8-7	SI	IUS	BEL	SUB		⋎	?	"								8-7	
	9	9	9	9										9	9	9	9		
	12				12						12	12		12	12		12		
			11				11				11	11	11		11	11	11		
							0				0	0	0		0	0	0		

Card Hole Patterns

- | | | | | |
|-----------------|----------------|---------|------------|---|
| ① 12-0-9-8-1 | ⑤ No Punctures | ⑨ 12-0 | ⑬ 0-1 | ⑰ On some chain configurations, the lozenge (⋈) is printed for this bit pattern, but this is nonstandard. |
| ② 12-11-9-8-1 | ⑥ 12 | ⑩ 11-0 | ⑭ 11-0-9-1 | |
| ③ 11-0-9-8-1 | ⑦ 11 | ⑪ 0-8-2 | ⑮ 12-11 | |
| ④ 12-11-0-9-8-1 | ⑧ 12-11-0 | ⑫ 0 | | |

Control Character Representations

ACK Acknowledge	EOT End of Transmission	RES Restore
BEL Bell	ESC Escape	RS Reader Stop
BS Backspace	ETB End of Transmission Block	SI Shift In
BYP Bypass	ETC End of Text	SM Set Mode
CAN Cancel	FF Form Feed	SMM Start of Manual Message
CC Cursor Control	FS Field Separator	SO Shift Out
CR Carriage Return	HT Horizontal Tab	SOH Start of Heading
CUI Customer Use 1	IFS Interchange File Separator	SOS Start of Significance
CU2 Customer Use 2	IGS Interchange Group Separator	SP Space
CU3 Customer Use 3	IL Idle	STX Start of Text
DC1 Device Control 1	IRS Interchange Record Separator	SUB Substitute
DC2 Device Control 2	IUS Interchange Unit Separator	SYN Synchronous Idle
DC3 Device Control 3	LC Lower Case	TM Tape Mark
DC4 Device Control 4	LF Line Feed	UC Upper Case
DEL Delete	NAK Negative Acknowledge	VT Vertical Tab
DLE Data Link Escape	NL New Line	
DS Digit Select	NUL Null	
EM End of Medium	PF Punch Off	
ENQ Enquiry	PN Punch On	

Special Graphic Characters

¢ Cent Sign	- Minus Sign, Hyphen	⋊ Hook
· Period, Decimal Point	/ Slash	⋍ Fork
< Less-than Sign	, Comma	⋋ Chair
(Left Parenthesis	% Percent	
+ Plus Sign	_ Underscore	
Logical OR, Absolute	> Greater-than Sign	
& Ampersand	? Question Mark	
! Exclamation Point	: Colon	
\$ Dollar Sign	# Number Sign	
* Asterisk	@ At Sign	
) Right Parenthesis	^ Prime, Apostrophe	
; Semicolon	= Equal Sign	
⋎ Logical NOT	" Quotation Mark	
[Left Bracket	\ Backslash	
] Right Bracket	^ Circumflex	

● Figure 14. Extended Binary Coded Decimal Interchange Code

If less than 240 bit patterns are sent to load the 240-character storage, the remaining positions are not disturbed. At least one byte must be sent during a loading operation. In all the announced chain (train) sets, the first character is the "1" (normal bit pattern: 1111 0001). Loading begins at 240-character storage position one, and continues until the storage is completely loaded or the CCW data count goes to zero. The SLI flag should be on in any UCS load CCW that transfers less than 240 bit patterns in order that the incorrect-length indication can be avoided.

Channel-end and device-end are presented to the channel as soon as the UCS gate command is accepted by the 2821 (command immediate). For the UCS load commands:

1. Channel-end is presented after data transfer to the 240-character buffer is completed.
2. Device-end is sent after the 240-character buffer addressing controls are synchronized with the chain (or train) timing.

If an even-parity data byte is detected in the 2821 during the 240-character storage loading procedure, sense bit 5 (UCS parity) and unit-check status (bit 6) are set on. In this case, unit-check is presented with both channel-end and device-end. (If the same check on parity for a byte from the 240-character storage is detected during printing, unit-check is presented with device-end. If the check is detected during printing when the channel has not yet accepted channel-end, unit-check is indicated with channel-end.)

The CCW folding operation code (1111 0011) causes folding of the entire first, second, and third quadrants of the EBCD Interchange Code into the fourth quadrant. The hexadecimal characters 01, 41, 81, and C1 all print as an uppercase A when folding is in effect. This occurs because the bits which define the quadrants are not used in the print-compare circuits (see Figure 14). The basic purpose of this CCW is to permit incoming uppercase and lowercase data (e.g., from teleprocessing keyboards that may commonly transmit uppercase and lowercase codes) to print out on printers using only an uppercase arrangement (for example, a 48AN arrangement; see Figures 12 and 13).

As an example of folding, consider the case in which a 1050 I/O device sends dual-case alphabetic characters in a data record to main storage, and this data record is subsequently sent to the printer using the 48AN arrangement.

From Figure 14 it can be seen that the only difference in the upper and lower case alphabetic bit patterns is in bit position 1. In essence, the folding

CCW causes this bit position to be ignored when comparing the transmitted data record with the contents of the 240-character storage.

Therefore, in the case described (of a 1050 dual-case code transmission for printer output on an uppercase arrangement, such as that on the AN arrangement), the CCW folding operation code accomplishes the intended purpose.

If system operation is such that the lowercase bit patterns are never sent to a printer with only the uppercase characters on its chain, then the other operation code (1111 1011, no folding) should be used.

When the folding capability is used to load a 240-character storage:

1. The folding capability is retained until power is turned off in the 2821, or until the no-folding operation code is used to change the contents of the 240-character storage.
2. If power is turned off, the contents of the 240-character storage are retained but the folding capability is lost. Therefore, the folding CCW must be reissued to the 2821 following each power-on of the 2821 if retention of the folding capability is desired.

If the UCS gate command, or either UCS load command (folding or no folding), is sent to a printer that does not have UCS, the command is rejected (unit-check, status bit 6, and command reject, sense bit 0).

Data-Check Control

Two commands provide program control of data check (indicated in normal operations by status bit 6 and sense bit 4). A data-check condition should be recognized in normal operations. Suppose, however, that an operation such as the following is attempted:

1. The 240-character storage is loaded with bit patterns for a specific character arrangement (such as the 48AN), and
2. The application run is stopped so that an assembly listing can be done.

It is likely that the assembly listing operation will result in sending many incomparable data bit patterns to the 2821/1403 with UCS. This situation occurs because many of the bit patterns used for instructions and addresses are not the same as the bit patterns loaded into the 240-character storage. Because of the data checks that would result, many error recovery operations would be required.

To avoid this situation, the operator can make use of the commands:

<u>Operation Code</u>	<u>Command</u>
01110011	Block-data-check
01111011	Reset-block-data-check

The block-data-check command prevents data checks until the reset-block-data check is given or until power to the 2821 is turned off. These commands operate in a manner similar to No-op. That is, channel-end and device-end occur together after either the block-data-check or the reset-block-data check command is accepted by the 2821.

The block-data-check or the reset-block-data-check command must:

1. be issued alone, or
2. be the first command of a chain, or
3. follow the UCS gate load command without any intervening write, skip, space, or UCS load (folding or no folding) command.

If the block-data-check or the reset-block-data-check command does not meet either of these requirements, then that command is rejected. (Unit-check is presented in the initial-status byte because sense bit 0 is one.)

If the block-data-check or the reset-block-data-check command is issued to a printer that does not have UCS, a command reject results.

Even if data checks are not recognized (i.e., the block-data-check condition is in effect), printing speed is lowered when data-check conditions occur. (A data-check condition occurs if an incomparable data record code is sent to a 2821 with UCS. However, null or blank - or null, blank, and the bit patterns, 10000000 and 1100 0000, if folding is in effect - do not cause data checks.)

Printing Speeds

The printing speeds attained with this feature depend upon a number of factors. In general, printing speed for a particular character depends on its frequency of appearance on the print train or chain. Other factors such as spacing and format, however, affect the printing speed. This section presents a method for determining nominal and absolute-minimum printing speeds for character groups although the actual print speeds will usually be greater than the calculated nominal figures.

To prevent possible damage to the printer, character groups of less than 16 characters should not be entered into the 240-character storage. This means

that the same bit pattern should not be entered into the 240-character storage with an interval of less than 16 other discrete bit patterns. This restriction does not cause a decrease in printing speed, because the peak print speeds attainable with this feature are achieved with character groups greater than 16.

The following formulas are used to calculate the speed for a given set of characters on the chain or train.

Speed in Lines per Minute
IBM 1403-3 or 1403-N1

Nominal	Absolute Minimum
$\frac{60,000}{\left(\frac{240}{f} - 3\right) (.729) + 21.2}$	$\frac{60,000}{\left(\frac{240}{f}\right) (.729) + 21.2}$

IBM 1403-2

Nominal	Absolute Minimum
$\frac{60,000}{\left(\frac{240}{f} - 1\right) (1.665) + 21.7}$	$\frac{60,000}{\left(\frac{240}{f}\right) (1.665) + 21.7}$

where:

f = Number of times the given set of characters appear on the train.

and:

$\frac{240}{f}$ must equal a whole number.

Note: In any case, the maximum printing speed for the 1403-N1 cannot exceed 1400 lpm. Hence, if a calculate speed exceeds this 1400 lpm limit, the 1400 lpm figure is used. In the case of the 1403-2, the maximum printing speed cannot exceed 750 lpm.

This feature utilizes an end-of-print line concept to permit immediate carriage movement when a printed line is complete. As a result, the printing speed is variable, and can be in excess of the calculated nominal speeds.

The two formulas apply for continuous printing with single-line spacing. When skipping or multiple spacing operations are performed, the additional forms movement time must be added to the denominator of the formulas. Figure 15 shows the forms movement times to be added to the formula denominator.

Consider, for example, calculation of the speed (by formula) for a 48AN train configuration. The number of times the complete 48AN configuration appears on the train is 5:

$$\frac{240}{48} = 5 \text{ presentations of 48 AN set.}$$

Therefore, f (in the nominal formula for the 1403-3) equals 5. For continuous printing and single line spacing with the AN train:

$$\frac{60,000}{\left(\frac{240}{5} - 3\right) (.729) + 21.2} = 1111 \text{ LPM}$$

Now consider the same 48AN configuration but with spacing of two lines after each line printed. Figure 15 shows that the 21.2 factor, in the denominator of the nominal formula for the train printer, is replaced by 25. Nominal speed at which printing occurs (assuming continuous printing and spacing) is then:

$$\frac{60,000}{\left(\frac{240}{5} - 3\right) (.729) + 25} = 1038 \text{ LPM}$$

Universal Character Set Utility Program

The following information describes the general characteristics of the Universal Character Set Utility Program. This utility program, provided by IBM, allows the user to load the 240-character storage (in the 2821) with bit patterns that correspond to the character arrangement of the desired chain or train. The entire contents of the 240-character storage is then checked against the installed chain or train graphics by a printout of all graphics in the sequence in which they occur on the chain (or train).

Program Operation. The utility program deck information is entered into the system by use of the load key on the processing unit console. The utility program then reads the address cards and determines the number of 240-character storages to load. The first chain or train image codes are read and loaded into the appropriate 240-character storage. The entire contents of the 240-character storage is then checked against the installed chain or train graphics by a printout of all graphics in the sequence in which they occur on the chain (or train).

The program procedure of loading 240-character storage and printout is repeated until all desired 240-character storages have been loaded and printed out.

When the wait light comes on, all storages have been loaded and the printouts should then be checked by the operator.

Lines Skipped	Time Required (ms)*
2	25
3	30
4	35
5	40
6	45
7	50
8	55

Each space over eight requires an additional 2.3 ms for all models.

Note: In the 1403 Model N1 equipped with the stacking improvement device, some lines beyond the first eight skipped may require longer than 2.3ms for certain unique skipping formats.

* The figure to be substituted in the speed calculation formulas' denominator for the 21.2 or 21.7 figure.

Additional value to be added to the 8-line figure of 55 is that which results by multiplying the number of spaces (in excess of eight) times 2.3 ms.

Example:

12 lines skipped

55 + 4 (2.3)

or 64.2 ms.

Figure 15. Form-Movement Times

Configurations

Any 1403-2, 1403-3, or 1403-N1 attached to a 2821 control unit in System/360 can have the Universal Character Set feature. When the feature is installed for one printer, both the 2821 to which that printer is attached and the printer itself are modified by this feature. A 1403 without the Universal Character Set feature, however, can be used with a 2821 Control Unit having the Universal Character Set adapter only if the printer uses the previously announced A through K arrangements or the 48AN or 48HN arrangements.

Print Chains and Trains (Selection and Design)

The available arrangements are described in detail in the introductory Description section. Also, any previously announced 1400 series chain or train can be used with this feature. Customers designing their own chains or trains should consult with their IBM Sales Representative for order forms and the type-slug catalog prepared to facilitate designing and pricing of new slugs, if required.

Note that Figures 12 and 13 represent an actual printout of the graphics on the appropriate chain or train. For example, if the graphics on the AN chain were to be printed out in the sequence in which they are mounted on the chain, then the printout would be as shown for the AN chain in Figure 12. (Note that this is not the way the graphics appear if the chain itself is observed.)

When ordering a chain or train, use order form 120-1089. This form is laid out in printout sequence (i.e., the same as the sequence shown in Figures 12 and 13). The bit pattern sequence in the 240-character storage also corresponds to the printout sequence. Position one of the 240-character storage always contains the bit pattern that corresponds to the graphic "1" on the chain or train (except possibly when certain non-English graphics are used on the chain or train). The "1" graphic is a special marked slug (colored) that designates the beginning of a train cycle (in 1403 Model 3 and N1 printers only). Identical bit patterns for the other "1" graphics are stored in other 240-character storage locations, depending upon the train configuration used.

As an example, consider use of a 48AN train for which the EBCD Interchange Code is used to load the 240-character storage. The first three characters on the train and their corresponding 240-character storage bit patterns are:

<u>Graphic</u>	<u>240-Character Storage Position</u>	<u>EBCDIC Bit Pattern</u>
1 (marked)	1	11110001
2	2	11110010
3	3	11110011

The assigned bit patterns for the graphics of all arrangements are as outlined in the standard EBCD Interchange Code (see Figure 14).

For the SN arrangement, which contains one graphic (the "long dash" which is not the same as the underscore) not uniquely defined in the standard EBCD Interchange Code, the card hole pattern, 12-11-0-8-7, has arbitrarily been assigned.

For the TN arrangement, which contains 32 graphics not uniquely defined in the standard EBCD Interchange Code, the recommended card hole patterns assigned are shown in Figure 16. These codes may be redefined by the customer. Note, however, that if they are redefined, the "chain image deck," forwarded with the cartridge, must be similarly amended. The bit patterns that correspond to the card hole patterns defined (in Figure 16) for the TN arrangement are as shown for these same card hole patterns in Figure 14.

Chain or Train Design

In a 48-character set chain or train, the 48-character set is presented identically five times to occupy the 240 type positions of the chain or train. Each time the chain or train moves one character position, a new character is presented to each print position. To present each of the 48 different characters to each print position, the chain or train must move one character spacing 48 times. The time interval between the presentation of two successive characters to a print position is called a scan time. Therefore, 48 scan-times are required to present each character of the 48-character set to each print position.

The printing speed (in lines per minute) is directly related to the number of scan-times required to present each character to a printing position. For the 60-character set print train (or chain), 60 scan-times are required. For the 80-character set, 80 scan-times are required, etc. The chain or train moves at its same respective rate of speed in all cases. Therefore, the character set with the greatest number of different characters has the slowest line-per-minute print speed.

The 1403 printers not using the Universal Character Set feature generally have their print train or chain characters arranged in ascending binary coded order. This is necessary because the electronic control circuitry, which is used to advance through the character codes, incorporates a binary counter.

When the Universal Character Set feature is used, however, the coded contents of the 240-character storage is used to advance through the chain or train. Therefore, chain or train character sequence is related only to the bit patterns loaded into the 240-character storage.

Note: Repeated character sets on the chain must be arranged in the same order so that the calculated line-per-minute rates can be achieved.

With the Universal Character Set feature, it is possible to use preferred arrangements of two or more interlaced sets of graphics. Each set then has its own total number of scan-times and related print speed. In the examples following, all indicated speeds are nominal (as defined by the nominal formula).

Consider a 60-45 preferred character arrangement with single-line spacing of forms. Instead of showing specific graphics in our example, we are substituting numbers for the characters, because a binary code sequence need not be observed when this feature is used. What we are doing then, is showing the relationship of like characters on the train being

designed. For example, if the character designated by the number 15 (in the first set) is an A, then any time the number 15 is used in subsequent sets, the letter A is again designated.

Figure 17 lists suggested graphics and the corresponding EBCD bit patterns and hole patterns. It is essential that the PL/I graphic bit-patterns correspondence (shown in Figure 17) be used if the system is programmed with the Programming Language/I. (See also Figure 14.)

The first 45-character subset and the first three characters of the 60-character subset are shown at the top of Figure 18. Note that the characters of the 60-character set are shown in groups of three because we are considering the design of a print train (1403-3 and 1403-N1). If we were designing a print chain (1403-2), the characters would be grouped on the chain in groups of two. These groupings depend upon the graphics that are on one type slug: three on train type-slugs and two on chain type-slugs.

For the train shown in Figure 18:

1. There are five sets of characters of the 45-character subset. There is one set of the additional 15 that makes up the 60-character subset.

45-character subset presented	
five times	225
Characters 46 through 60	15
Total type positions	240

2. The 45-character subset is arranged at regular intervals. That is, there are always 48 scans between like characters (for example, from character 16 to character 16).
3. The 15 extra characters (46 through 60) are distributed evenly in groups of three.
4. There are 240 scans between the repeat scanning of any one of the 15 extra characters. This results because a whole chain revolution of 240 characters must occur before the same character is again referenced to any one print position (i.e., position 46 to 46).
5. For a 1403-3 printer:
 - a. A line containing any of characters 1 through 45 prints at a nominal speed of 1110 lpm because 48 scans are required (assuming continuous single-line printing).
 - b. A line containing any of characters 46 through 60 (as well as the full complement of characters 1 through 45) prints at 310 lpm because 240 scans are required.

The most frequently used type slugs in the 45-character and 60-character preferred set train would probably be obtained directly from the type catalog, whereas the five slugs containing characters 46 through 60 would frequently be special slugs.

Note: A straight 60-character set (identical sets of 60-characters presented four times) would print a line containing any or all the 60 characters at a rate of 955 lpm.

A second example is a three-level preferred arrangement (Figure 19). This train is a 48-66-78 preferred arrangement. For this train:

1. There are four 48-character subsets, two 49-66 character subsets, and one 67-78 character subset.

48-character subset presented four times	192
18-character subset (49-66) presented two times	36
12-character subset (67-78) presented once	12
Total type positions	240

2. The 48-character subset is at regular intervals, 60 scans apart. Print rate for the 48-character subset is 955 lpm.
3. A line containing any of characters 49 through 66 (as well as the full complement of characters 1 through 48) that appear at regular intervals of 120 scans (there are two sets of characters 49 through 66), prints at 560 lpm.
4. The remaining 12 characters (67 through 78) appear at regular intervals within 240 scans, and print at about 310 lpm.

A straight 80-character set (repeated identically three times on the train) would print at the single speed of 775 lpm.

Any line of text, no matter what character set is used, might under optimum conditions reach a maximum rate of 1400 lpm (1403-3 and 1403-N1) or 750 lpm (1403-2). The calculated rates given for the examples are nominal rates that occur during continuous printing at single-line spacing. Generally the rate is higher than that computed from the formulas. It is conceivable that a hypothetical condition could reduce the nominal rates slightly.

Graphic	EBCD		Graphic	EBCD	
	Hole Patterns	Bit Patterns		Hole Patterns	Bit Patterns
		Bit Positions 0123 4567			Bit Positions 0123 4567
A	12-1	1100 0001	s	11-0-2	1010 0010
B	12-2	0010	t	11-0-3	0011
C	12-3	0011	u	11-0-4	0100
D	12-4	0100	v	11-0-5	0101
E	12-5	0101	w	11-0-6	0110
F	12-6	0110	x	11-0-7	0111
G	12-7	0111	y	11-0-8	1000
H	12-8	1000	z	11-0-9	1001
I	12-9	1001	Space	No Punches	0100 0000
J	11-1	1101 0001	(+) ⌈ Cent Sign, Left Bracket	12-8-2	1010
K	11-2	0010	Period, Decimal Point	12-8-3	1011
L	11-3	0011	< Less-Than Sign	12-8-4	1100
M	11-4	0100	(Left Parenthesis	12-8-5	1101
N	11-5	0101	+ Plus Sign	12-8-6	1110
O	11-6	0110	! Absolute, Logical OR, Exclamation Point	12-8-7	1111
P	11-7	0111	& Ampersand	12	0101 0000
Q	11-8	1000	(+) !] Exclamation Point, Right Bracket	11-8-2	1010
R	11-9	1001	\$ Dollar Sign	11-8-3	1011
S	0-2	1110 0010	* Asterisk	11-8-4	1100
T	0-3	0011) Right Parenthesis	11-8-5	1101
U	0-4	0100	; Semicolon	11-8-6	1110
V	0-5	0101	⌘ ^ Logical Not, Circumflex	11-8-7	1111
W	0-6	0110	- Minus Sign, Hyphen	11	0110 0000
X	0-7	0111	/ Slash	0-1	0001
Y	0-8	1000	, Comma	0-8-3	1011
Z	0-9	1001	% Percent Sign	0-8-4	1100
0	0	1111 0000	_ Underscore	0-8-5	1101
1	1	0001	> Greater-Than Sign	0-8-6	1110
2	2	0010	? Question Mark	0-8-7	1111
3	3	0011	:	8-2	0111 1010
4	4	0100	# Number Sign	8-3	1011
5	5	0101	@ At Sign	8-4	1100
6	6	0110	' Prime, Apostrophe	8-5	1101
7	7	0111	= Equal Sign	8-6	1110
8	8	1000	(+) " Quotation Mark	8-7	1111
9	9	1001	⌋ Hook	12-0-9-8-4	1100 1100
a	12-0-1	1000 0001	⌋ Fork	12-0-9-8-6	1100 1110
b	12-0-2	0010	⌋ Chair	11-0-9-8-4	1110 1100
c	12-0-3	0011	\ Backslash	0-8-2	1110 0000
d	12-0-4	0100			
e	12-0-5	0101			
f	12-0-6	0110			
g	12-0-7	0111			
h	12-0-8	1000			
i	12-0-9	1001			
j	12-11-1	1001 0001			
k	12-11-2	0010			
l	12-11-3	0011			
m	12-11-4	0100			
n	12-11-5	0101			
o	12-11-6	0110			
p	12-11-7	0111			
q	12-11-8	1000			
r	12-11-9	1001			

The lower case alphabetic and those special graphics designated by (‡) are not used in the Programming Language/I graphics. If a system is using the Programming Language/I, the PL/I graphics must be used (with corresponding bit patterns as shown above) on the print chain or train.

• Figure 17. Suggested Graphics and Codes for Print Chain or Train Design

PROGRAMMING TIMING CONSIDERATIONS (FOR PRINTERS WITHOUT THE UNIVERSAL CHARACTER SET FEATURE)

Maximum Time from Channel-End to Device-End

=Maximum print time + carriage motion time -X +3 ms (for double or triple spacing)
LPM Minimum Print time

83.3 ms	600	81.6 ms
36.5 ms	1100	35.7 ms
Carriage Motion Time =	6 ms for single space + 5.0 ms for each additional line up to 8 lines + 2.3 ms for each line beyond 8 lines.	

Motion time for STL operations on the 1403-N1 (i.e., 2821 feature code 6425; 1403-N1 feature code 6420) is calculated in the same manner. For the STL feature used on the 1403-2 or 1403-3 or 1403-N1, motion time is 12 ms.

Note: For 1403-7, all additional spaces (beyond 8) also require 5 ms.

X = 3.3 ms of pre-energize time before carriage motion is overlapped with printing for the 1403-2.

X = 2.9 ms for the 1403-3 and 1403-N1.

Print-buffer loading should be overlapped with the 15.7 ms of carriage-settling time following device-end. This gives maximum throughput.

Minimum Time between Two Write Command = Minimum print time + carriage motion time + 15.7 ms settling time -X.

Settling time for STL operations on the 1403-N1 (i.e., 2821 feature code 6425; 1403-N1 feature code 6420) is 15.7 ms. For the STL feature used on the 1403-2 or 1403-3 or 1403-N1, settling time is 9.7 ms.

Channel transfer of one byte to the print buffer requires 5 microseconds in burst mode.

For a printer timing diagram, refer to Figure 20.

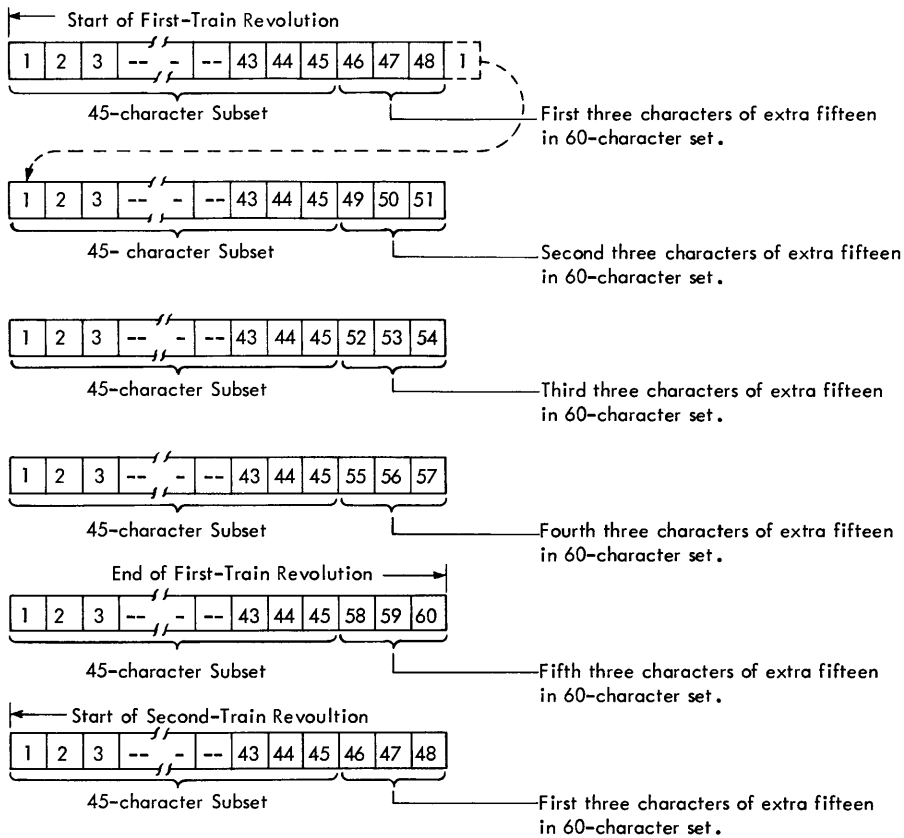

Note that the 45-character set is repeated identically five times in one train revolution. The 15 extra characters of the 60-character set are each presented only once per train revolution.

Figure 18. 45- and 60-Character Preferred Set Print Train

The minimum times from generation of channel-end to generation of device-end are:

Lines per Minute	Operation	Time (milliseconds)
600	Write (no auto-space)	81.6
1100	Write (no auto-space)	35.7
600	Write and single space	82.8
1100	Write and single space	38.7
600	Write and skip	78.3 + carriage motion time
1100	Write and skip	34.2 + carriage motion time

IBM 1404 PRINTER

The IBM 1404 is described in IBM 1404 Printer, Form A26-1446. The following descriptions refer to

the method of control used when the IBM 1404 Printer is connected to the IBM 2821 Control Unit Model 4 on IBM System/360.

Buffering

The data to be printed, whether in the 1403 mode or in the card mode, is buffered in the control unit. The write command from the channel causes data to be transmitted across the interface from main storage to the buffer in the control unit. A channel-end is issued either upon a stop (CCW data count has gone to zero - no data chaining) from the channel or when the buffer is filled.

If the read-compare special feature is installed and activated, the data from the card(s) is stored in a different section of the same buffer used for the printer record. A maximum of thirty columns can be read from one or both cards, depending upon the user's wiring of the control panel in the 1404. This data is stored in thirty positions of the buffer that are not used for printing. Hence, overlapping of card reading and printing is achieved. The first

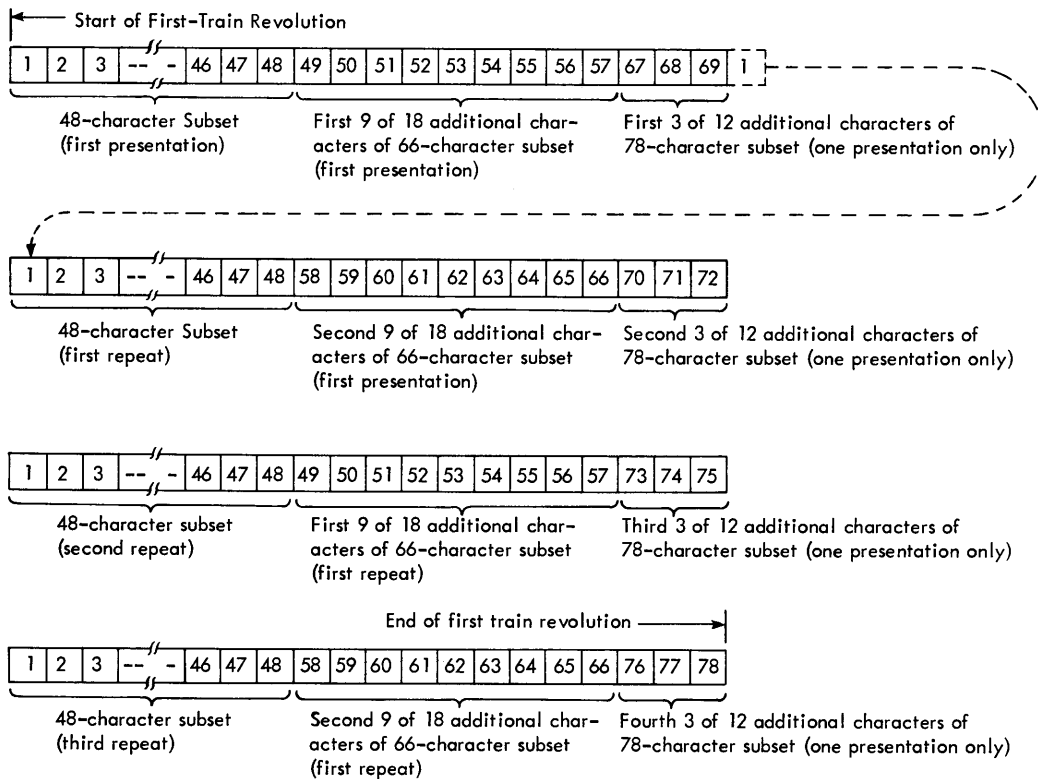

Figure 19. Print Train Comprised of Preferred 48-, 66-, and 78-Character Subsets

position (of the 30 positions) corresponds to the first position in main storage referenced by the CCW used.

Data Codes

With the Read-Compare feature (requires the Read-Compare Adapter on the 2821 Model 4), the 1404 can read EBCD Card Code. The only invalid punched-card hole pattern is one in which more than one punch occurs in rows 1 through 7 of a single card column. The standard translator translates the EBCD Card Code to the EBCD Interchange Code.

Character Sets

The IBM 1404 Printer uses the same basic 48-character sets as in the 1403 used with the IBM 2821 Control Unit, Models 1, 2, 3, and 5. An interchangeable-chain-cartridge feature is offered for style, font, and graphic replacement.

Addressing

The address of the 1404 is set in the control unit in a programmable card by the Customer Engineer at installation. The printer retains the same address

whether in 1403 mode or in card mode. With the card mode Read-Compare feature, this same address is used to control the readout of the reader buffer.

Method of Operation

If the print mechanism is adjusted for 1403 mode, control of the 1404 is identical to the 1403. When the 1404 is in card mode, (i.e., print mechanism moved to left side and card feed switch set on), a skip to channel 1 causes a card-feed cycle, which advances all cards one station. The skip to channel 1 can be achieved by:

1. A skip-to-channel-1-immediately command.
2. A special feed-and-write command (subsequently described).
3. A write and skip to channel 1 after printing.

Any of these commands cause card feeding. That is, the card at the print station goes to the stacker, the card in the alignment station moves into the first-line print position (channel 1), the card in the pre-read station moves to the alignment station, and the card in the hopper moves to the pre-read station.

While the commands applicable to the 1404 as a printer are the same as those for the 1403, a special

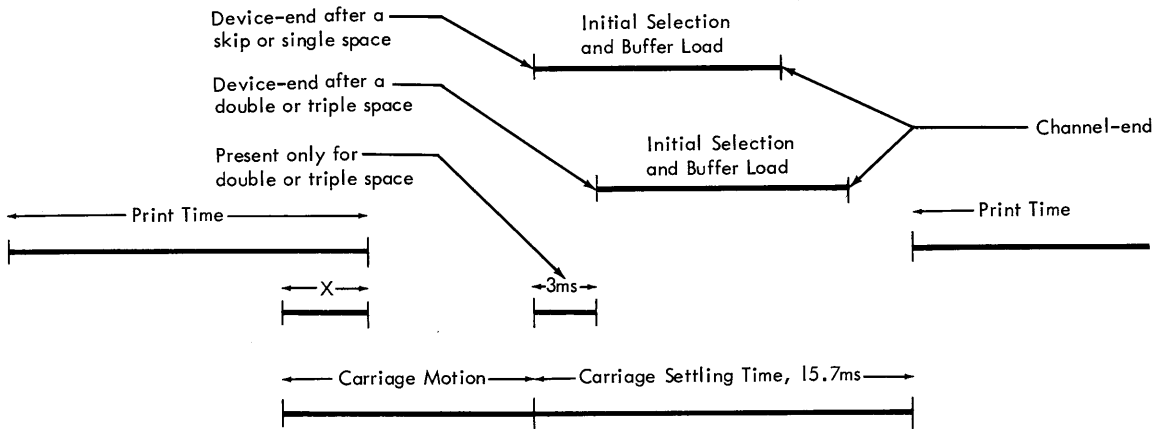

Pre-energize: X = 3.3ms (1403-2 and 1403-7)
 X = 2.9ms (1403-3 and 1403-N1)

Figure 20. Printer Timing Diagram

feed-and-write command, unique to the 1404, is added to provide overlap of printing and card reading. (The special feed-and-write command is obtained by setting bit 5 of a normal write command to a 1.) This command permits printing the first line of a card with overlapped reading of the next card into the buffer.

First, the feed-and-write command causes data to be sent from main storage to the printer buffer. The 1404 transport then advances all cards one station. The card passing the read brushes is read into the buffer. As soon as the lead card enters the printing position, printing begins from data stored in the buffer. After printing, any spacing or skipping indicated by modifier bits in the feed-and-write command is executed.

If the modifier bits (in the feed-and-write command) indicate a skip to channel 1, an invalid-command indication occurs. If the modifier bits indicate a skip to a carriage brush channel that is read during the card feed cycle, a portion of the feed cycle is done with the carriage moving at slow speed (instead of the normal high speed). The number of spaces moved at slow speed can vary from one to eight.

If only a single line of print is desired for each card, none of the modifier bits should be set on in the feed-and-write command. This gives maximum speed to the 1404 in this operation.

Device-end occurs for a normal write or for a feed-and-write command at the end of printing without a carriage operation, or after any carriage operation performed. After device-end, the next command can be given so that buffer loading is overlapped with carriage settling time.

Device-end for an independent carriage operation also occurs after the carriage operation unless the Read-Compare feature is present. With the Read-Compare feature, device-end occurs when card reading is completed.

Cards are read into the buffer as they pass under the read brushes (located between the pre-read and alignment stations). Card reading is initiated by either:

1. A skip-to-channel-1-immediately command, or
2. A feed-and-write command.

Data is not read from cards when a normal write and skip to channel 1 command is given.

A maximum of thirty columns of data can be read into the buffer by properly wiring the 1404 control panel. Those positions not wired are omitted.

The read command (0000 0010) causes data to be sent from the buffer to the channel. The transfer rate depends on the type of channel and the setting of the 2821 CE Panel Mode Switch. Channel-end and device-end occur when the operation is stopped by the channel, or when a buffer count of 30 occurs.

Different sections of the same buffer are used for both card reading and printing. Therefore, transfer of card data to main storage can be done at any time except while printing or feeding cards.

Unusual Command Sequence

Unless programming precautions are observed, certain command sequences may result in lost or erroneous data.

Two successive read commands without an intervening card feed (i.e., feed and write, or immediate skip to channel 1) cause the same data to be sent to main storage twice. This is indicated by unit-check status (due to unusual command sequence sense) at channel-end of the second read operation.

Also, consider the commands:

- A. 1000 1001 Write and Skip to Channel 1 After Printing
- B. 1000 1011 Skip to Channel 1 Immediately
- C. xxxx x101 Feed and Write

If any one of the following sequences of these commands occurs without an intervening read command, it will be executed. Unit-check status (due to unusual command sequence sense) is indicated with either device-end or channel-end for the second command:

- C followed by B
- C followed by A
- B followed by A
- C followed by C

In each case, cards are printed, but any information read from cards on the preceding command is lost (i.e., not transferred to main storage).

Invalid-Command Sequence

Certain command sequences are invalid in card mode. The commands involved are:

- M 1000 1001 Write and Skip to Channel 1 After Printing
- N 1000 1011 Skip to Channel 1 Immediately
- P xxxx x101 Feed and Write

Any of the following sequences are rejected (unit-check at initial selection of the second command due to command reject sense) when there is no intervening write or read command:

- M followed by P
- N followed by N
- N followed by P
- M followed by N

Note that if any of these sequences were allowed, cards would pass through the 1404 without being printed or read.

Card Run-In Procedure

If machine conditions warrant, pressing the 1404 start key places the machine in the ready state and

feeds the first card(s) (2 up) into the alignment position. The first card (or cards, 2 up) are read into the buffer if the read-compare is activated.

The card data in the buffer can then be sent to the processing unit. Then a skip to channel 1 or a feed-and-write command causes all cards to move forward one station. The first card then moves to the print position and is either printed or is ready for printing, depending on the feed instruction used.

Card Runout Procedure

If the hopper(s) in the feed(s) selected by the Channel Select Switch (on 1404) empties, the 1404 goes to a not-ready condition. This is indicated by a unit-check status at initial selection for the next command. (Bit one of the sense byte indicates intervention required.) By placing three blank cards in the hopper(s) used and pressing the start key, you can process the last cards. The 1404 operates until the hopper(s) empties again. At this point, the 1404 enters a not-ready state.

To perform a process-runout when the hopper(s) empties, press the start key. Cards are then fed until the last card is fed from the print station. The 1404 is then taken out of a ready condition.

Checking

No checking except for an invalid card code is performed on the card reading in the Read-Compare feature. Normally, this data is compared, by programming, to another record for a matching condition (such as an account number) and is thereby checked. Absence of the expected match could indicate an error.

At channel-end, after a read command, an invalid card code is indicated by unit-check, and the sense byte contains a 1 in bit-4 for invalid card code. Printing checks are the same as for the 1403 printer.

Operation Commands

The following commands are valid for the IBM 1404 Printer:

- Read from buffer
- Write
- Feed and write
- Control
- Sense

The specific commands are:

<u>Interface Bits</u>	<u>Function</u>
<u>01234567</u>	
00000001	Write (no automatic space)
00001001	Write and space 1 line after printing
00010001	Write and space 2 lines after printing
00011001	Write and space 3 lines after printing
10001001	Write and skip to channel 1 after printing
10010001	Write and skip to channel 2 after printing
10011001	Write and skip to channel 3 after printing
10100001	Write and skip to channel 4 after printing
10101001	Write and skip to channel 5 after printing
10110001	Write and skip to channel 6 after printing
10111001	Write and skip to channel 7 after printing
11000001	Write and skip to channel 8 after printing
11001001	Write and skip to channel 9 after printing
11010001	Write and skip to channel 10 after printing
11011001	Write and skip to channel 11 after printing
11100001	Write and skip to channel 12 after printing
00000100	Sense
xxxxx101	Feed and write

x modifier bits are set in the same manner as the write commands to cause the desired skipping or spacing after printing.

Independent carriage operations are expressed by modified control commands as follows:

<u>Interface Bits</u>	<u>Function</u>
<u>01234567</u>	
00011011	Space three lines immediately
10001011	Skip to channel 1 immediately
10010011	Skip to channel 2 immediately
10011011	Skip to channel 3 immediately
10100011	Skip to channel 4 immediately
10101011	Skip to channel 5 immediately
10110011	Skip to channel 6 immediately
10111011	Skip to channel 7 immediately
11000011	Skip to channel 8 immediately

<u>Interface Bits</u>	<u>Function</u>
<u>01234567</u>	
11001011	Skip to channel 9 immediately
11010011	Skip to channel 10 immediately
11011011	Skip to channel 11 immediately
11100011	Skip to channel 12 immediately
00000011	No-op

The bit structure for the read command is:

00000010

Test I/O

The description of Test I/O in the 2540 section applies equally to the 1404.

Diagnostic Check Read Command (00000110)

This command is described here, but it is intended for Field Engineering use in diagnostic tests. It is valid only if the 1404 has the Read-Compare feature.

Diagnostic check read is used to transmit information from the card-read section of the buffer to the channel to locate a position in the buffer that is causing validity checks.

The data transmitted is:

<u>Bit</u>	<u>Function</u>
4	If on, indicates a validity-check condition for the position checked.
5 and 6	Not used. May or may not contain bits.
7	Parity check bit

The validity (4) and parity (7) bits can be used to locate the position of an error without taking the 1404 off-line.

Channel-end and device-end occur at channel-stop (CCW count goes to zero) or at a buffer count of 30 for this command.

Status Byte

The status-byte definition for the 1404 in card mode for printing and carriage control is the same as for the 1403 with the following additions for bit 6 (unit-check):

- Command reject. An invalid command sequence is given.

- Intervention required:
 - a. 1404 hopper empty
 - b. 1404 stacker full
 - c. 1404 card-transport check
- Unusual command sequence. An unusual command sequence is given.

The status byte definition for the 1404 in card mode for read transfer operations is the same as for the 1403 with the following additions for bit 6 (unit-check):

- Command reject. A read command is given when the Read-Compare feature is not present.
- Invalid card code. More than one punch is read from rows 1 through 7 in a single card column.
- Unusual command sequence. A read command follows a read command without an intervening card feed.

Sense Byte

The sense-byte definition for the 1404 in card mode for print and carriage control is the same as for the 1403 with the following additions:

- Bit 0 (command reject). An invalid command sequence is given.
- Bit 1 (intervention required).
 - a. 1404 hopper empty
 - b. 1404 stacker full
 - c. 1404 card-transport check
- Bit 6 (unusual command sequence). An unusual command sequence is given when the Read-Compare feature is present.

The sense-byte definition for the 1404 in card mode for the read transfer operations is the same as for the 1403 with the following additions:

- Bit 0 (command reject). A read command is given when the Read-Compare feature is not present.
- Bit 4 (data check). More than one punch is read from rows 1 through 7 in a single card column.
- Bit 6 (unusual command sequence). A read command follows a read command without an intervening card feed.

Programming Timing Considerations

The timing of the IBM 1404 Printer with respect to the IBM 2821 Control Unit Model 4, is the same as that for the IBM 1403-2 Printer and the IBM 2821 Models 1, 2, 3, and 5. The buffering cycle rate for reading from and loading the print buffer is 5.5 microseconds per byte.

1404 Use-Meter

The 1404 use-meter operates in the same manner as the 1403 use-meter when the 1404 is operated in 1403 mode.

If the 1404 print unit is adjusted for card-mode operation, the 1404 meter starts recording after the 1404 is ready and has become busy executing a command. The meter continues to run as long as the 2821 meter runs and the 1404 is on line. It stops when the 1404 space or restore key is operated, or when the 1404 card-feed transport is emptied.

TWO-CHANNEL-SWITCH SPECIAL FEATURE

The two-channel switch makes it possible for I/O units attached to the IBM 2821 Control Unit Models 1, 2, 3 and 5 (but not Model 4) to operate with either of two channels. The two channels can be any combination of multiplexer or selector channels on the same or on different processing units. This feature can be used by 2821s attached to IBM System/360 Model 67 only.

Operation of the 2821 on either of two channels provides such time-sharing advantages as:

- Switching of the 2821 to either one of two channels on the same system for the same job.
- Reserving of one or more I/O units attached to a channel on one of two CPUs. The other I/O units can then be reserved to the other CPU. (When a unit is reserved to a channel, it can operate with that channel only.)

- Reserving of the 2821 to one channel on a CPU until the associated job is completed. (Then the 2821 can be reserved to a second channel for use in a subsequent application.)

When the two-channel-switch feature is used, control of the 2821 (and its attached I/O units) is changed only with respect to the additional program and manual control needed to implement switching between the two channels.

Manual Control

Two toggle switches (on the 2821 - Figure 21) are provided for manual control. They are called partitioning switches. Each switch controls the logical connection of the 2821 to a specific channel.

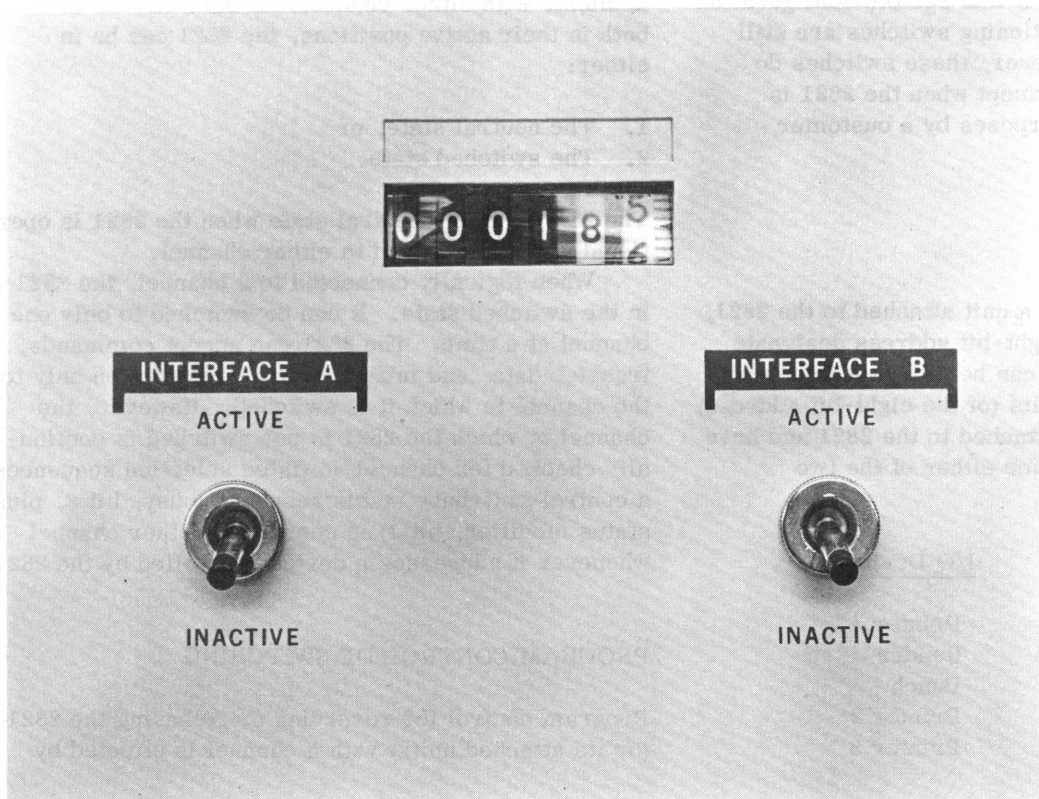

Figure 21. Partitioning Switches

If a partitioning switch is in the active position, the 2821 can communicate with the channel associated with that switch. If, however, a partitioning switch is in the inactive position, the 2821 cannot communicate with the channel associated with that switch.

If a partitioning switch is placed in the inactive position while an operation is still in progress (with the channel associated with the switch), the 2821 becomes partitioned from that channel after:

1. Any operation in progress between the affected channel and any 2821-controlled I/O unit is completed (that is, the devices are no longer busy with the channel), and
2. The processing unit has entered either the wait or stopped state.

Any further reference in this manual to a switch in the inactive state implies that steps 1 and 2 have occurred.

Note that each switch controls connection of the 2821 to one channel only. If both switches are in their active positions, control of the 2821 and its attached I/O units for each channel is determined by programming. If both switches are in their inactive positions, the 2821 cannot communicate with either channel.

Remote control of partitioning is available as a feature. The partitioning function is then centrally controlled by a remote configuration console (IBM 2167 Configuration Unit). If this remote configuration console is used, two partitioning switches are still located on the 2821. However, these switches do not control partitioning, except when the 2821 is modified for diagnostic purposes by a customer engineer.

Addressing

When a channel addresses a unit attached to the 2821, the first five bits of the eight-bit address designate the 2821. These five bits can be different for each channel. The last three bits (of the eight-bit address) pertain to an I/O device attached to the 2821 and have the following fixed values for either of the two channels:

<u>Bits 5 6 7</u>	<u>I/O Device</u>
000	Printer 1
001	Reader
010	Punch
011	Printer 2
100	Printer 3

The fixed values must be used for the devices listed. If any of these devices are not attached to the 2821, the unused addresses can be assigned to other units on the channel. For example, assume that only the following addresses are needed:

<u>2821 Portion of Address</u>	<u>Unit Portion of Address</u>
00001	000 (Printer 1)
00001	001 (Reader)
00001	010 (Punch)

Because Printer 2 and Printer 3 are not attached to the 2821, addresses 00001 011 and 00001 100 can be used for other devices on the channel.

The first five bits of the unit address are determined for each channel at installation. The address configurations are then set into the control unit by the customer engineer.

States of the Control Unit

As already noted, when the partitioning switches are both in their inactive positions (that is, the 2821 is partitioned from both channels), the 2821 cannot communicate with either channel. If the switches are both in their active positions, the 2821 can be in either:

1. The neutral state, or
2. The switched state.

The 2821 is in the neutral state when the 2821 is operational and not switched to either channel.

When logically connected to a channel, the 2821 is in the switched state. It can be switched to only one channel at a time. The 2821 can accept commands, transfer data, and initiate status presentation only to the channel to which it is switched. However, the channel to which the 2821 is not switched is continually checked for channel-initiated selection sequences; a control-unit-busy status response (busy, bit 3, plus status modifier, bit 1) is sent to this other channel whenever it addresses a device controlled by the 2821.

PROGRAM CONTROL OF SWITCHING

Program control for reserving or releasing the 2821 (or its attached units) with a channel is effected by

special sense commands. (These commands all have bit three of their operation codes set to a value of one.) The special sense commands are:

<u>Command</u>	<u>Operation</u>	<u>Byte</u>	<u>Effect on</u>	<u>Effect on</u>
			<u>2821</u>	<u>Device</u>
		<u>01234567</u>		
00010100			release	release
00110100			release	reserve
01010100			reserve	release
01110100			reserve	reserve
10010100			unchanged	release
10110100			unchanged	reserve
11010100			release	unchanged
11110100			reserve	unchanged

When one of the special sense commands is accepted by the 2821, a normal sense operation also occurs.

Any of the special sense commands must be the first command of a chain, if chaining is used. If command chaining is used, and a special sense command is processed at any time other than the first command in the chain, it is rejected. Command reject (bit 0 of the sense byte) is sent by the 2821 to the channel on a subsequent normal sense operation. (Note that sense information is reset only upon

acceptance of commands other than Test I/O, Sense, or No-op.)

When one of the special sense commands is sent to the 2821, normal addressing for the designated device occurs. (The address is specified in the Start I/O instruction that initiates the I/O operation.) Reserving or releasing of the 2821 and addressed I/O device occurs only if the command is processed by the 2821. Whether or not it is processed depends upon the activity of the 2821 and addressed device with the other channel.

Programming must take into account the status that is returned when a unit is addressed. This status information is summarized in Figure 22 for the conditions that can occur. These status combinations are applicable only to two-channel-switch operations and are in addition to the 2821 normal status responses.

Type of Control-Unit Connections

Three types of connections to a channel for the 2821 two-channel switch are:

1. Implicit,
2. Contingent, and
3. Reserved.

Status Returned to Channel B	Condition
Bits 0 1 2 3 4 5 6 7	
1. 0 1 0 1 0 0 0 0	a. The 2821 is reserved to channel A, or b. The 2821 is not reserved to channel A, but it is busy with channel A (implicit or contingent connection). (This status is presented to addressing by channel B until after all device data transfers are completed and there are no outstanding channel ends for channel A .)
2. 0 1 1 1 0 0 0 0	The 2821 has an outstanding control unit end to present to channel B, and channel B addresses an I/O unit attached to the 2821. This combination occurs only if channel B previously addressed an I/O unit attached to the 2821 and received status combination 1.
3. 0 0 1 0 0 0 0 0	Given if the status presentation sequence was initiated by the 2821. Occurs only if channel B previously addressed an I/O unit attached to the 2821 and received status combination 1. When this status is sent by the 2821, the address presented is for printer 1 regardless of which unit attached to the 2821 was originally involved in the operation.
4. 0 0 0 1 0 0 0 0	a. If channel B addresses an I/O unit reserved to channel A, or b. If channel B addresses an I/O unit released from channel A but that I/O unit is still involved in completing the operation with channel A.
5. 0 0 0 1 0 1 0 0	This status is sent to channel B for any channel B initiated command other than a test I/O, but only if channel B previously received combination 4 and if the I/O unit has reached device-end and the device-end has not as yet been accepted by channel B.
6. 0 0 0 0 0 1 0 0	Given in response to a test I/O command from channel B, or given if the 2821 initiates status presentation to channel B. Given, however, only if channel B previously received combination 4.

Status Bit	Meaning
1	Status Modifier
2	Control Unit End
3	Busy
5	Device-End

Figure 22. Status Responses to Channel-B

An implicit connection is not explicitly controlled by the program (that is, not the result of program reservation of the 2821 by one of the special sense commands).

The 2821 is control-unit busy (busy, bit 3, plus status modifier, bit 1) to channel-B for the entire duration of the implicit connection with channel-A. The implicit connection lasts from the initiation of a command to a device until all the data-transfer requirements for that command have been handled, and no outstanding channel-end exists. The minimum duration of an implicit connection is the time required by a single communication sequence (such as for a Test I/O operation).

A contingent connection is one that is maintained until the program provides the required intervention. A contingent connection is maintained (by the 2821 with a two-channel switch) for either of two situations:

1. If unit-check status is presented to the connected channel. (The contingent connection is maintained until the 2821 has accepted a command other than a Test I/O or No-op for each device that presented unit-check status.)
2. If command chaining is in progress for a device attached to the 2821. (The contingent connection is maintained until initial selection for the next command or until the command chaining ends.)

A reserved connection is established by reserving the 2821 to a channel through use of one of the special sense commands. When the 2821 is reserved to a channel, it remains reserved until:

1. The reserving channel releases the 2821 through use of one of the special sense commands, or
2. Power drops on the channel to which the 2821 is reserved, or
3. The 2821 is partitioned from the channel to which it is reserved (see the Manual Control section), or
4. A reset is issued by the channel to which the 2821 is reserved. (See the Removal of a Device from the Reserved Condition section.)

During the duration of the reservation, the 2821 is control-unit busy (busy, bit 3, plus status modifier, bit 1) to the other channel.

OPERATIONS WITH THE TWO-CHANNEL SWITCH

Assume that the 2821 and all attached I/O devices are not reserved to either channel. Suppose that sense command 01010100 (reserve 2821, release device) is sent from channel-A and accepted by the

2821. The 2821 and all of its attached I/O devices can now communicate with channel-A. Even though the sense command specifies that the addressed device is released, that device cannot process commands sent from channel-B, because the 2821 is reserved to channel-A. Hence, whenever the 2821 is program-reserved to a channel, the other channel cannot initiate commands to any I/O unit attached to the 2821. In this case, status returned to channel-B's addressing of any unit is control-unit busy (bits 1, status modifier, and 3, busy in the status byte both set to a value of 1).

Before channel-B can reserve the 2821 (or any attached device), the 2821 must first accept a special sense command from channel-A to release the 2821. If channel-A sends a sense command that specifies unchanged, for the 2821, the 2821 remains reserved to channel-A.

After the 2821 has been released by channel-A, the 2821 initiates a sequence that presents control-unit end (bit 2 of the status byte set on) to channel-B. This control-unit end is sent only if channel-B previously addressed a unit attached to the 2821 and received a status byte with bits 1 and 3 set on. If this control-unit-end status (from a 2821 initiated sequence) has not been accepted by channel-B before channel-B addresses one of the units attached to the 2821, the 2821 returns the following status to channel-B:

1. Status modifier (bit 1),
2. Control-unit end (bit 2), and
3. Busy (bit 3).

After channel-B receives this status, it must reissue a command to initiate the desired operation. Note that this status is sent to channel-B only if channel-B previously addressed a unit attached to the 2821 and received a status byte with bits 1 and 3 set on.

As a second example, assume that the sense command 01110100 (reserve 2821, reserve device) has been accepted by the 2821 for channel-A. Suppose also that channel-A subsequently issues sense command 1101000 (release 2821, device unchanged), which is accepted by the 2821. Channel-B can now communicate with the 2821. However, the device specified in the sense commands sent by channel-A is still reserved. Therefore, any commands from channel-B to the reserved device do not initiate an I/O operation. If channel-B sends a command to the reserved device, the 2821 returns busy status (bit 3 alone, no status modifier) to channel-B.

Now assume that the 2821 is released, and the device is also released by a sense command that is the first of a chain issued by channel-A. Channel-B cannot initiate any I/O operation with the released

device until device-end is accepted by channel-A for the last command of the chain. If channel-B addresses this device during processing of any command in the chain, the 2821 returns busy status (bit 3 alone, no status modifier).

After device-end has occurred for the last command in the chain (for channel-A), the 2821 sends an unsolicited device-end (via a control-unit-initiated selection sequence) to channel-B if channel-B attempted to select the device while it was busy with channel-A. If this device-end is accepted by channel-B, all zero status (assuming no other unusual conditions have occurred) is sent to channel-B on any subsequent selection by channel-B. However, if channel-B does not accept the unsolicited device-end, device-end and busy are returned to channel-B if it attempts to select the unit. Channel-B must accept the device-end and busy status and then reselect the device to process any command with the device.

If channel-B does not attempt to select the unit before the device-end is accepted by channel-A, subsequent selection by channel-B results in a normal status response (that is, all zeros if no unusual condition exists) to any channel-B selection sequence.

Note that if a channel has already obtained control of the 2821 (and a unit that the channel is addressing), status response to that channel is normal (that is, as if the two-channel switch was not present). The only situation in which the same status is available to either channel is when device-end occurs for a not-ready-to-ready transition. As soon as this device-end is accepted by either channel, the status to both channels is cleared at the 2821.

Duration of Connection

Even though an I/O unit is released by a special sense command, any operation (including all chaining) in progress with the releasing channel is completed before the other channel can obtain control of the I/O unit.

For the 2821, the connection is, in general, maintained until after:

- All data transfers have been completed and no channel-ends are outstanding. (During command chaining, a connection is also maintained from device-end until the succeeding channel-end, or until command chaining is terminated by the channel.)

The 2821 is control-unit busy (status bits 1 and 3) to the other channel until channel-end occurs and is accepted by the communicating channel. If, however, unit-check status (bit 6) is presented by any I/O unit involved, the connection is maintained until any command (except a Test I/O or No-op) is accepted by the 2821 for each device causing a unit-check.

For any I/O unit released, the connection is maintained for at least the duration of any communication sequence in progress (for that unit) between the channel and the 2821. The connection is further maintained until after device-end is accepted, if device-end is a result of the operation. Hence, the device-end referred to may be the one that occurs for the last command in the chain. After device-end is accepted by the channel, the device is placed in the neutral state (if not otherwise reserved).

Suppose, however, that a chaining operation is in progress for channel-A and that channel-end has occurred for a command in the chain. Between the time that channel-end is accepted and device-end occurs for the same command, channel-B can request and obtain service for a device other than the one being chained by channel-A. Channel-B then obtains control of the 2821 and can cause a command(s) to be executed for the addressed device. Device-end for the last command on channel-A is simply held at the 2821 as long as the 2821 is involved in transfer of status, data, or commands for the operation initiated by channel-B. The 2821 can operate with only one channel at a time. In other words, it is not possible to transfer data, commands, or status between the 2821 and two channels simultaneously.

In the case of the 2540 read, feed, and no stacker selection compatibility command, the 2821 connection is maintained until the device-end that occurs after the card feed is accepted.

Removal of a Device from the Reserved Condition

Besides acceptance by the 2821 of a special sense command, the other conditions that can remove a unit from the reserved condition are:

1. Partitioning occurs:
 - a. The partitioning switch, pertaining to the channel to which the unit is reserved, is placed in the inactive position.

Table 1 Control Unit Resetting											
Allegiance of:		Effect of Reset on:									
Control Unit	Connection of Control Unit to Channel		Control Unit Allegiance		Current Control Unit Operation		Control Unit Status for RC		Control Unit Status for OC		
	Gen	Sel	Gen	Sel	Gen	Sel	Gen	Sel	Gen	Sel	
Switched to RC	R	R	R	N	R	R	R	R	N	N	
Neutral	-	-	-	-	-	-	R	-	N	-	
Switched to OC	N	-	N	-	N	-	R	-	N	-	

Table 2 Device Resetting										
Allegiance of:		Effect of Reset on:								
Control Unit	Device	Device Allegiance		Current Device Operation		Device Status for RC		Device Status for OC		
		Gen	Sel	Gen	Sel	Gen	Sel	Gen	Sel	
Switched to RC	Switched to RC Communicating	R	N	R	N	R	R	N	N	
	Switched to RC not communicating	R	N	R	N	R	N	N	N	
	Neutral	-	-	-	-	R	N	N	N	
	Switched to OC	N	N	N	N	R	N	N	N	
Neutral	Switched to RC	R	-	R	-	R	-	N	-	
	Neutral	-	-	-	-	R	-	N	-	
	Switched to OC	N	-	N	-	R	-	N	-	
Switched to OC	Switched to RC	R	-	R	-	R	-	N	-	
	Neutral	-	-	-	-	R	-	N	-	
	Switched to OC	N	-	N	-	R	-	N	-	

RC = The channel signaling the reset
 OC = The other channel

R = The reset will be performed
 N = The reset will not be performed
 - = Not applicable
 Gen = General reset
 Sel = Selective reset

Figure 23. Effects of Resetting on the 2821 and the I/O Device

- b. All 2821 I/O units become not-busy to that channel, and
- c. The processing unit enters the wait or stopped state.

Resetting by a channel is effective only if that channel's power is on and the 2821 is not partitioned from that channel. The effect of resets are summarized in Figure 23.

If a general reset is given while any device is executing an I/O operation, the 2821 is control-unit busy (status modifier, bit 1, plus busy, bit 3) to both channels for about 250 milliseconds. After this time has elapsed, control-unit end status (bit 2) is presented to the channel(s) that received control-unit busy status.

- 2. Power drops on the reserving channel.
- 3. The reserving channel issues a general reset (a system reset).

- Addresses (Preferred) 11
- Addressing (Printer) 34
- Addressing (Two-Channel Switch) 66
- Addressing (1404) 60
- Addressing (2540) 12
- Attaching Units to 2821 7
- Attachment Method 8
- Attention (Printers) 36
- Attention (2540) 22
- Auxiliary Ribbon Device 46

- Blank 47
- Block Data Check 53
- Buffering 9
- Buffering (1404) 59
- Bus-Out Check (Printers) 37
- Bus-Out Check (2540) 23
- Busy (Printers) 36
- Busy (2540) 22

- Card Read-Punch (2540) 12
- Carriage 32
- Carriage Keys 43
- CAW 6
- CE Control Panel 11
- CE Mode Switch 9
- Chains 48
- Channel Address Word 6
- Channel End (Printers) 36
- Channel End (2540) 22
- Channel Status Word 6
- Channel 9 (Printers) 37
- Channels 6
- Character Sets 32
- Character Sets (1404) 60
- Checking (Printer) 34
- Checking (1404) 62
- Check-Reset Key (Printer) 42
- Chips Light (2540 Punch) 28
- Column Binary (2540) 28
- Command Reject (Printers) 36
- Command Reject (2540) 22
- Commands (Two-Channel Switch) 67
- Commands (1403) 35
- Commands (1404) 62
- Commands (2540) 14
- Compatibility Attachment (2540) 28
- Concurrent Operation 8
- Configurations (UCS) 54
- Connections (Two-Channel Switch) 67
- Control Panel (CE) 11
- Control Unit End (Printers) 36
- Cover Raise and Cover Lower (1403-N1) 44
- CSW 6

- Data-Check Control (UCS) 52
- Data Check (Printers) 37
- Data Check (2540) 23
- Data Codes 9
- Data Codes (1404) 60
- Data Codes (2540) 20
- Data Mode 1 (2540) 20
- Data Mode 2 28
- Data Mode 2 (2540) 20
- Data Movement 8
- Design (Chains, Trains) 54, 55
- Device End (Printers) 36
- Device End (2540) 22
- Diagnostic Check Read Command (1404) 63
- Diagnostic Commands (Printers) 42
- Diagnostic Commands (2540) 26
- Dualing 32
- Dualing (UCS) 50
- Duration of Connection (Two-Channel Switch) 69

- End-of-File Key (2540 Punch) 28
- End-of-File Key (2540 Reader) 27
- End-of-File Light (2540 Punch) 28
- End-of-File Light (2540 Reader) 27
- End-of-Forms Light (Printer) 43
- Equipment Check (Printers) 37
- Equipment Check (2540) 23

- Feed and Select Stacker (Type BA) 18
- Feed-Stop Light (2540 Punch) 28
- Feed-Stop Light (2540 Reader) 27
- Fifty-one Column Card (2540) 29
- Folding 52
- Forms-Check Light (Printer) 43
- Fuse Light (2540) 27

- Halt I/O 11

- Incorrect Length (2540) 15
- Indicators (Printer) 42
- Indicators (2540) 27
- Input/Output Initiation (General) 5
- Interchangeable Chain Cartridge 44
- Interface Disconnect 11
- Intervention Required (Printers) 36
- Intervention Required (2540) 23
- Invalid-Command Sequence (1404) 62

Keys (Printer) 42
 Keys (2540) 27

Malfunction Reset 10
 Meter Switch 8
 Method of Operation (1404) 60
 Mode Switch 9

No-Op (Printers) 35
 No-Op (2540) 20
 Null 47

Operation Commands (2540) 14
 Operation Method (1403) 34
 Operations (Two-Channel Switch) 68
 Overrun (2540) 23

PFR Feature 28
 PFR (Method of Operation) 13
 PFR Write, Feed, and Select-Stacker (Type BA) 18
 Power Light (2540) 27
 Power-On Light (1403-N1) 43
 Preferred Addresses 11
 Print-Check Light 43
 Printer (1404) 59
 Printers 31
 Printing Method 34
 Printing Positions 31
 Printing Principles 34
 Printing Speeds (UCS) 53
 Priority of Units 8
 Program Status Word 5
 Punch-Check Light (2540) 28
 Punch (Method of Operation) 13

Read and No Feed or Stacker Select (Type AB) 16
 Read, Feed, and No Stacker-Select
 (Compatibility) 17
 Read, Feed, and Select Stacker (Type AA) 15
 Reader (Method of Operation) 12
 Ready Light (Printer) 43
 Ready Light (2540 Punch) 28
 Ready Light (2540 Reader) 27
 Reset Block Data Check 53
 Resets (with Two-Channel Switch) 70
 Restore Key (Printer) 43
 Run-In (1404) 62
 Run-Out (1404 Card) 62

Selection (Chains, Trains) 54
 Selective Reset 10
 Selective Tape Listing 44, 45
 Sense (Printers) 36
 Sense (2540) 20
 Sense Byte (Printers) 36
 Sense Byte (1404) 64

Sense Byte (2540) 22
 Sense Combinations (Printers) 41
 Sense Combinations (2540) 26
 Single-Cycle Key (Printer) 43
 SLI (2540) 15
 Space Key (Printer) 44
 Special Features Controlled 11
 Special Features (Printer) 44
 Special Features (2540) 28
 Start Key (Printer) 42
 Start Key (2540 Punch) 28
 Start Key (2540 Reader) 27
 Stacker Light (2540) 27
 Status (Two-Channel Switch) 68
 Status Byte (Printers) 36
 Status Byte (1404) 63
 Status Byte (2540) 21
 Status Combinations (Printers) 37
 Status Combinations (2540) 23
 Status Modifier (Printers) 36
 Status Modifier (2540) 22
 States of Control Unit (Two-Channel Switch) 66
 Stop Key (Carriage) 44
 Stop Key (Printer) 42
 Stop Key (2540 Punch) 28
 Stop Key (2540 Reader) 27
 Supervisor Call 5
 Suppress Length Indication Flag (2540) 15
 Switches (2540) 27
 Switches (2821) 8
 Switching (Two-Channel Switch) 66
 Sync Check Light (Printer) 43
 System Reset 9

Tape-Controlled Carriage 32
 Termination Operations 14
 Test I/O 20
 Test I/O (Printers) 35
 Timing (Printers without UCS) 58
 Timing (1404) 64
 Timings (2540) 29
 Trains 49
 Transport Light (2540) 27
 Two-Channel Switch 65
 Type-Codes (2540 Commands) 14
 Type (.079-Inch High) 46
 Type Format 31

UCS 46
 UCS Gate 50
 UCS Load 50
 UCS Parity (1403) 37
 Undefined-Graphic Bit Patterns 34
 Unit Check (Printers) 36
 Unit Check (2540) 22
 Unit Exception (Printers) 36

Unit Exception (2540) 22
Units Controlled 7
Universal Character Set 46
Unusual Command Sequence (1404) 37, 61
Unusual Command Sequence (2540) 23
Use Meter (1403) 42
Use Meter (1404) 64
Use Meter (2540) 30
Use Meter (2821) 9
Utility Program (UCS) 54

Validity Light (2540) 27

Write, Feed, and Select Stacker (Type BB) 19



International Business Machines Corporation
Data Processing Division
112 East Post Road, White Plains, N.Y. 10601
[USA Only]

IBM World Trade Corporation
821 United Nations Plaza, New York, New York 10017
[International]